

Specifications for Contractor Installed Manholes and Concrete Encased Conduit Systems

DCS-5
February 2025



Distribution Construction Specifications (DCS)

Contents

- I. Scope
- II. Definitions
- III. General
- IV. Company Responsibilities
- V. Contractor Responsibilities
- VI. Concrete Encased Conduit
- VII. Manholes
- VIII. Backfill and Compaction
- IX. Construction in the Vicinity of Substations
- X. Variances
- XI. Acceptance
- XII. Detail Sheets



I. Scope

This Specification, applied in conjunction with an approved design drawing, represents the minimum requirements for civil facilities installed by outside parties that will ultimately be owned by Oncor Electric Delivery Company. All designs provided by outside parties shall be compliant with the Texas Engineering Practice Act. Designs for manhole and concrete encased conduit systems shall include detailed plan and profile drawings.

This Specification may also be applied to facilities being installed by a firm pursuant to a contract with the Company.

II. Definitions

- A. **Company:** Oncor Electric Delivery Company and its designated representatives.
- B. **Designated Company Representative:** The person designated by the Company as the contact point and who has final responsibility for verifying that the facilities transferred to Company ownership are compliant with Company specifications and standards.
- C. **Contractor:** Individual or firm installing facilities covered by this specification. The term Contractor does not convey that the Contractor is performing the work pursuant to a contract with the Company.
- D. **Authority Having Jurisdiction:** Generally an incorporated municipality, but may be an agency of the county, state, or federal government.

III. General

The latest edition of all applicable codes, standards, and ordinances shall be complied with in the design and installation of the facilities covered by this specification. Codes, standards, and ordinances include, but are not limited to, the following:

- A. Local city building and fire codes
- B. Codes and ordinances applicable to a particular project location
- C. The National Electrical Safety Code
- D. U.S Occupational Safety and Health Act of 1970 (OSHA)
- E. American Concrete Institute Standards
- F. ASTM International
- G. Texas Department of Transportation Utility Accommodation Rules
- H. Local, city, state, and federal environmental regulations
- I. The Texas Engineering Practice Act and Rules Concerning the Practice of Engineering Professional Engineering Licensure

IV. Company Responsibilities

- A. The Company inspector is responsible for inspecting all manhole, conduit, and pad installations prior to the placement of concrete and/or backfill.
- B. The Company inspector is responsible for coordinating all field changes with design and project management personnel.
- C. All testing of concrete and backfill deemed necessary by the Company shall be performed by a testing laboratory and will be at the Company's expense unless there is clear evidence of workmanship issues and/or material deficiencies.

V. Contractor Responsibilities

- A. The Contractor shall locate and protect all existing utilities, whether indicated on the design drawings or discovered during the work process.
- B. The Contractor shall immediately notify the Company Inspector or Designated Company Representative when any utility not previously indicated or inaccurately indicated on the design drawing is discovered.
- C. The Contractor shall coordinate construction with all affected utility owners and shall provide access to the construction site with sufficient opportunity for utilities to complete necessary relocations, extensions, and modifications.
- D. The Contractor shall be responsible for removing standing water at the Contractor work site. The work site, including excavations, pits, and all other depressions, shall be maintained free of surface water.
- E. All environmental management requirements, including the Storm Water Pollution Prevention Plan, shall be the responsibility of the Contractor.
- F. The Contractor shall stockpile all material required for, or resulting from, the work in a manner which will minimize the obstruction of the natural flow of runoff.
- G. When construction operations are interrupted by unfavorable weather conditions, the Contractor shall prepare the work site to prevent pooling or erosion.
- H. The Contractor shall take all necessary precautions so that no tree is removed or trimmed except as directed by the Company. The Contractor shall use proper care to prevent damage to trees and vegetation which are to remain on the construction site.
- I. The Contractor is responsible for obtaining and implementing trench safety programs. Three copies of the trench safety specifications (certified by a professional engineer) shall be supplied to the Company before construction begins.
- J. The Contractor shall supply a construction schedule to the Company before staging material or equipment and prior to commencing construction activities.
- K. The Contractor shall supply all materials and labor for the project. This includes, but is not limited to, manholes, neck sections, frames and covers, concrete joint sealants, ground rods, conduit, bends, couplings, ties, spacers, primer, adhesive, backfill, pull tape, and precast and poured in place pads. All materials and installation methods shall comply with Company standards and specifications unless otherwise noted in Company documents.

- L. Unless otherwise noted in Company documents, the Contractor shall provide all supervision and surveying work required to insure that manholes and concrete encased conduit systems are constructed in accordance with the design and installed at the correct locations.
- M. The Contractor is responsible for obtaining city permits (if allowed by local authorities), and all construction shall be in accordance with city requirements unless otherwise specified by Company.
- N. Normally, all concrete shall be placed weekdays between the hours of 8:00 am and 4:30 pm. The Contractor shall notify Company inspector a minimum of 24 hours in advance of scheduling concrete deliveries and a minimum of 2 hours prior to the delivery of the concrete. The Company inspector shall be present for concrete placement.
- O. The Contractor shall be responsible for promptly cleaning paved streets that have been soiled by Contractor construction vehicles.
- P. The Contractor is responsible for installing ramps and protective measures for streets, curbs, sidewalks, and other facilities which may be damaged by construction activities.
- Q. The Contractor shall be responsible for traffic control plan and shall provide flag personnel, signage, and other requirements necessary to control traffic in accordance with city, state, or federal requirements.
- R. All unused excavation spoils shall be removed from the construction site by the Contractor.
- S. The Contractor shall supply Company with one set of as-built drawings upon completion of the project. If there is no deviation from original design drawings, the Contractor shall indicate on the drawing that project was "Constructed as Designed".
- T. The Contractor shall submit a written request to the Designated Company Representative prior to any construction modification which will change the number of conduit bends or change the overall conduit length by 10 percent. The written request must be submitted and approved prior to the construction modification being made.

VI. Concrete Encased Conduit

- A. All concrete encased conduits shall be encased with a minimum of 3" of concrete. The top conduits shall have a minimum cap of 3" or 6" depending on the design (refer to design drawings for duct section details). The top of all concrete encasements shall have a patterned finish and be topped with red dye.
- B. Concrete shall be 5 sack Portland Type I cement with 3/4" maximum aggregate size. The compressive strength shall be a minimum of 3000 psi at 28 days. The slump of the concrete may be increased by the Contractor to improve the flow and insure encasement only with the approval of the Company inspector or Designated Company Representative. At no time shall the concrete be placed with a front-end loader or by similar method.
- C. All concrete shall be installed by the use of a hopper, tremie, chute, or pump truck unless otherwise specified by Company inspector or Designated Company Representative. At no time shall the concrete be placed with a front-end loader or by similar method.
- D. Conduit which will be concrete encased shall be held down with screw jacks or equivalent means installed at intervals not exceeding 20' along the duct line. Any instance of floating or racking of conduits shall be immediately reported to Company Inspector or Designated Company Representative.

- E. Conduit for encasement shall be NEMA TC-6, DB-60, ASTM F512, rated for 90° C. All conduits shall be solid core 6" PVC unless otherwise specified (see Detail Sheet 11). All bends, elbows, and couplings shall be schedule 40 PVC with a minimum radius of 36'.
- F. The Contractor shall use snap lock type conduit spacers (see Detail Sheet 11). Purpose-designed base, intermediate and top conduit spacers shall be used.
- G. After duct lines are completed, the Contractor shall check each conduit by pulling a conduit swab and disk mandrel through the entire length of conduit. (a swab alone cannot detect a break or separation in the conduit). The Contractor shall also install a 6000 lb rated pull tape in each 6" conduit.

VII. Manholes

- A. The Contractor shall supply manholes unless otherwise noted in Company documents. The manhole shall consist of two or three precast concrete sections with each section having a maximum weight of 15,000 pounds. Manholes obtained from approved suppliers shall be used (see Detail Sheets X-X)
- B. Prior to manhole installation, the Contractor shall install a minimum of 18" of pea gravel beneath manhole.
- C. A crane shall be used to install manholes. The Contractor is responsible scheduling and operating the crane.
- D. The Contractor shall install sealant supplied with manholes on all interlocking joints prior to joining the sections.
- E. The Contractor shall install manhole neck sections, frame, and cover such that the top of the cover is at the grade specified in the design drawings. An entrance pad is required for installations that are not in paved areas. (see Detail Sheet X).
- F. The Contractor shall install 5/8" x 8' copper dad ground rods in the floor of the manhole at each sleeved location (2, 3, or 4 as specified). If rock is encountered, grounding provisions shall be as specified by the Company. All ground rods shall be installed prior to placement of top manhole section (due to height limitations). In no case shall ground rods be cut.

VIII. Backfill and Compaction

- A. The Contractor is responsible for providing and installing all backfill materials.
- B. Soil backfill shall be installed in 1 ft. maximum lifts. Each lift shall be compacted prior to installing the next lift.
- C. All backfill material shall be compacted to a minimum density of 95% unless otherwise approved by Company.
- D. Compaction testing, if required, shall be responsibility of the Company.
- E. Flowable concrete-based material shall be used in lieu of soil backfill if specified by the Company or if required by the Authority Having Jurisdiction.
- F. The Contractor shall bring all excavated areas to the specified final grade, if not specified, to the original grade.
- G. The existing top soil shall be replaced and shall be free of rock, clay and debris.

IX. Construction in the vicinity of substations

All work done on Oncor Station property shall be performed by a Company approved contractor and shall be supervised by an authorized Company representative.

X. Variances

- A. Request for variance to these specifications shall be submitted in writing to, and approved prior to construction by, the Designated Company Representative.
- B. Approved variances shall apply only to the particular project for which it was granted.

XI. Acceptance

- A. The Designated Company Representative shall meet with the Contractor and review the entire installation prior to accepting ownership of the facilities constructed by the Contractor. At the Company's discretion, acceptance may occur for subdivisions of the entire project.
- B. Any warranties or subsequent requirements shall be conveyed in writing at the time of acceptance.

XII. Detail Sheets

- A. Screening Clearances around Pad Mounted Equipment (Sheet 1)
- B. Clearance of Pad Mounted Transformers from Building (Sheet 2)
- C. Method of Providing Utility Company Equipment Ground (Sheet 3)
- D. Grouting Detail for Transformer Pad Windows (Sheet 4)
- E. Above Ground Clearances from Gas Meter Installations (Sheet 5)
- F. Guard Post Installation (Sheet 6)
- G. Manhole Large Two Way Precast Reinforced Concrete (Sheet 7)
- H. Manhole Large Three Way Precast Reinforced Concrete (Sheet 8)
- I. Manhole Large Four Way Precast Reinforced Concrete (Sheet 9)
- J. Manhole Neck, Ladder and Entrance Pad Installation (Sheets 10 & 11)
- K. Manhole Cover and Frame Detail (Sheet 12)
- L. Duct Terminator Alignments for Precast Concrete Manholes (Sheet 13)
- M. General Guidelines for Concrete Encased Duct Bank Installations (Non-Network) (Sheet 14)
- N. Design Specifications for Manhole and Conduit System Plan and Profile Drawings (Sheet 15)
- O. Instructions for Joining PVC Conduit (Sheet 16)
- P. Concrete Pad Poured in Place 25 kV Live Front Automated Supervisory Control Switchgear (Sheet 17)
- Q. Precast Deep Well Pad 25 kV Dead Front / Live Front Air Insulated Switchgear (Sheet 18)
- R. Precast Deep Window Pad for 25 kV Dead Front SF6 Insulated Switchgear (Sheet 19)
- S. Conduit Locations Dead Front Pad Mount 25 kV SF6 Insulated Switchgear (Manual Operation) (Sheet 20)
- T. Conduit Locations Dead Front Pad Mount 25 kV SF6 Insulated Switchgear (RSC Operation) (Sheet 21)
- U. Precast Concrete Vault for Subsurface Dead Front SF6 Insulated Switchgear (Sheet 22)
- V. Precast Concrete Vault for Subsurfaced Dead Front SF6 Insulated Switchgear (Sheet 23)
- W. Termination of Primary Conduit at Riser Pole (Sheet 24)

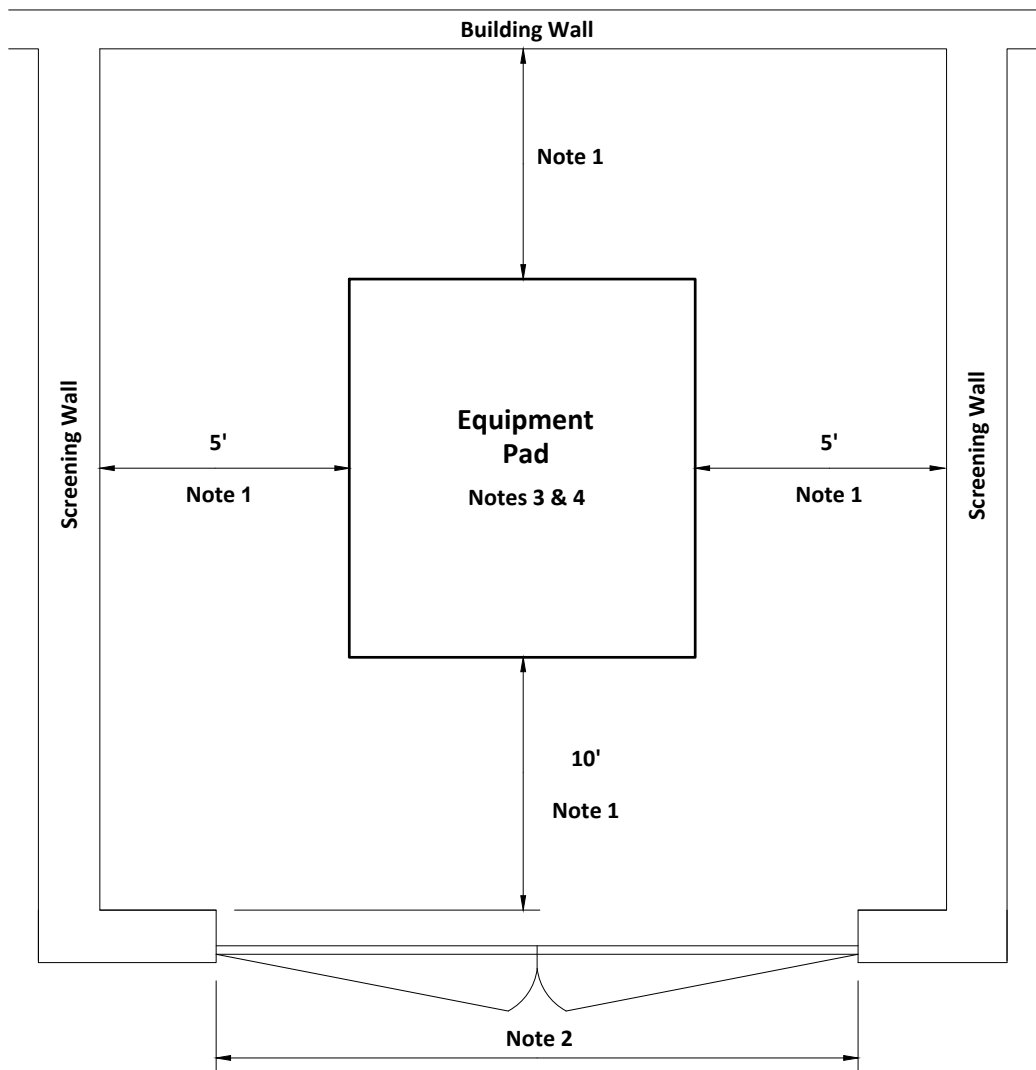

Notes:

1. Clearances to building walls shall be the greater of:
 - a. The clearances listed in Figure 2-D, page 21 for oil filled equipment
 - b. 10 feet on operating side
 - c. 5 feet on non-operating side
2. Gate shall open outward and the width shall be no less than 10 feet.
3. Where ground is flat or slopes toward building, fabricated secondary oil containment sufficient to contain all oil for transformers 500KVA or larger shall be installed. Contact Company Representative for details.
4. When transformers are installed, screening walls shall provide adequate ventilation.



**SCREENING CLEARANCES AROUND
PAD MOUNTED EQUIPMENT**

DCS - 5 Detail Sheet 1 of 24

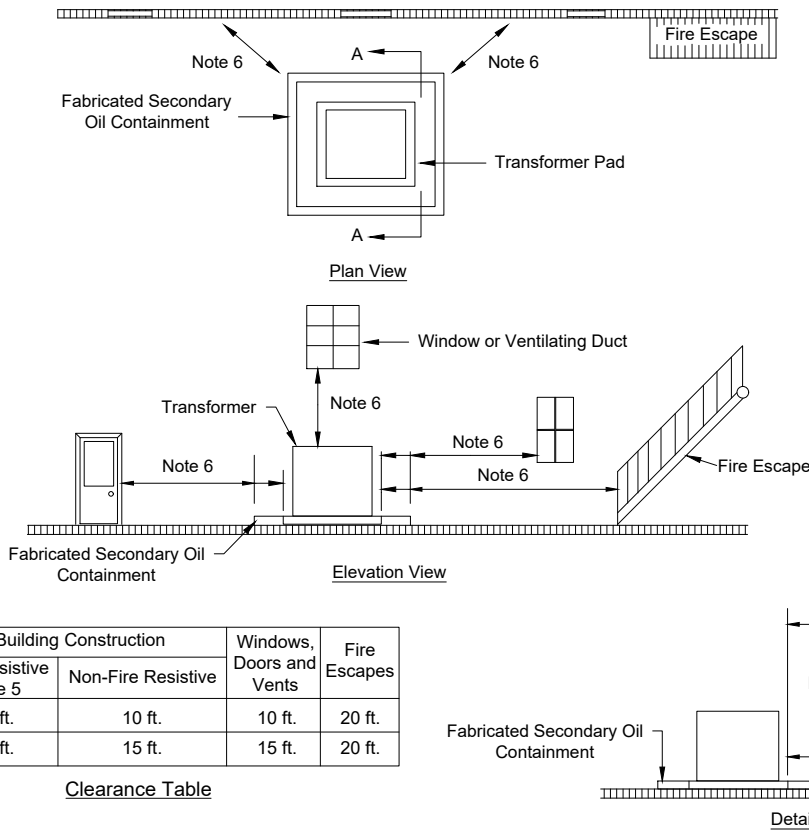

Transf. Type	Building Construction		Windows, Doors and Vents	Fire Escapes
	Fire Resistive Note 5	Non-Fire Resistive		
1 Phase	5 ft.	10 ft.	10 ft.	20 ft.
3 Phase	5 ft.	15 ft.	15 ft.	20 ft.

Clearance Table

Notes:

1. All clearances shall comply with the clearance table. All dimensions specified are minimal dimensions.
2. Oncor facilities shall not be installed over underground parking garages or similar building structures, located 10 feet or less below ground level, unless the Oncor facilities are installed in an Oncor approved vault.
3. Oncor facilities shall not be installed under any building extents (eaves, overhangs, balconies, etc) unless the Oncor facilities are installed in an Oncor approved vault.
4. If the building has an extent, the building's reference point for measuring clearances is based on the height of the extent. Where the extent is 35 feet or more above ground level, clearances shall be measured horizontally from the building wall to the edge of the equipment pad or oil containment, if used. Where the extent is less than 35 feet above ground level, clearances shall be measured horizontally from the building extent's drip-line to the edge of the equipment pad or oil containment, if used.
5. To meet the fire-resistant dimensions, all material including building extents must meet a minimum 2-hour fire rating. Exception, if the extent is located 35 feet or more above ground level, only the wall is required to meet the 2-hour fire rating.
6. Clearance to building doors, windows, vents and fire escapes shall be measured radially from closest point of the Oncor equipment or oil containment, if used.
7. If hot stick use is required on operating side of pad mounted equipment, a 10 feet minimum clearance shall be maintained.
8. There should not be any ground level obstructions, such as, but not limited to, dedicated parking places, shrubs, cooling towers, gas meters, fencing, etc. within 10 feet of the operating side of the equipment or 5 feet from the non-operating side of the equipment.
9. Liquid flow in the immediate area surrounding Oncor transformers should be away from buildings. Where the ground is flat or slopes toward buildings, a fabricated secondary oil containment sufficient to contain all transformer oil for transformers 500 kVA and larger shall be provided.
10. There shall not be any piping or conduit under the pad, except mutually agreed upon communication conduits entering the transformer.



CLEARANCES OF PAD MOUNTED TRANSFORMERS FROM BUILDING

Foreign utility
company ground
Note 1

A
6" from
pad's edge

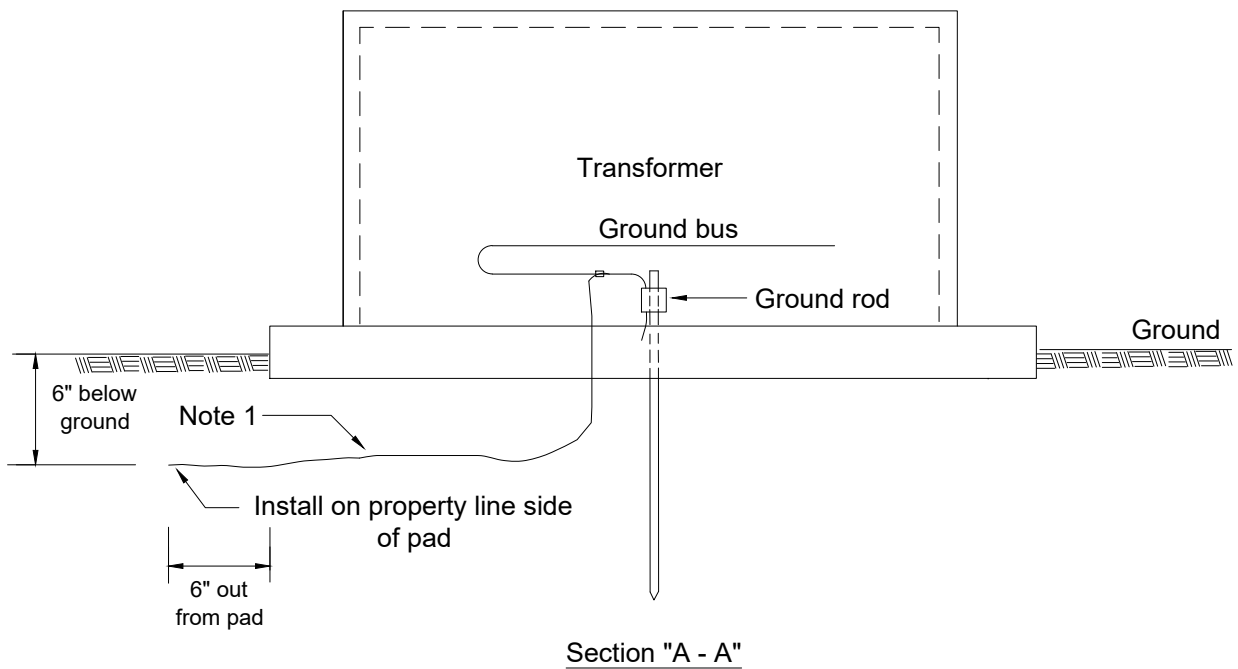
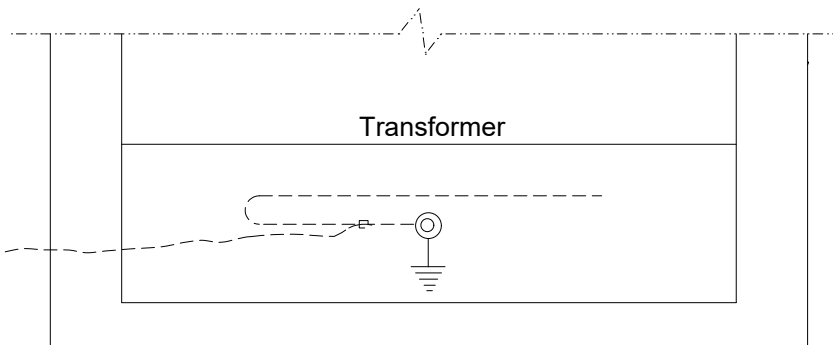

Notes:

1. On new installations, install #6 s.d. bare copper as shown for foreign utility company bonding.
2. The national electrical safety code rule 384 C recommends bonding of all above ground metallic power and communications apparatus (pedestals, terminals, apparatus cases, transformer cases, etc.) that are separated by a distance of 6' or less.



**METHOD OF PROVIDING
UTILITY COMPANY
EQUIPMENT GROUND**

DCS - 5 Detail Sheet 3 of 24

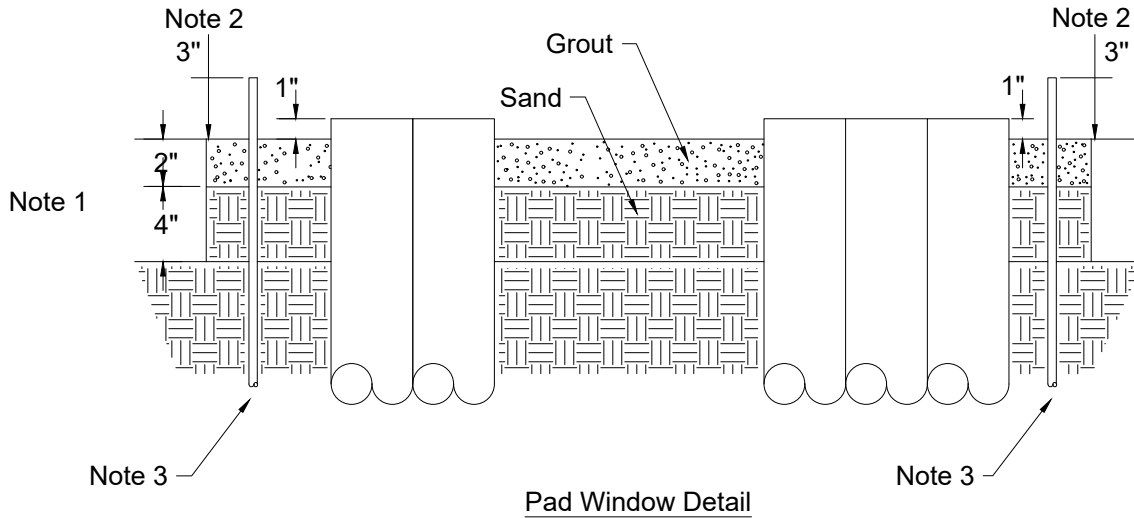
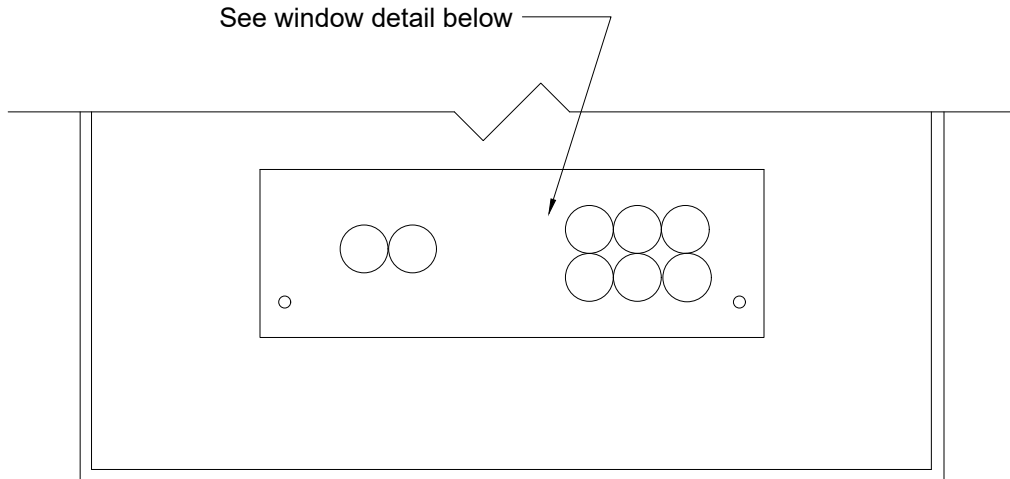

Notes:

1. The grout shall be portland based and sanded. Do not use concrete.
2. Fill in pad window with 4" of earth backfill and 2" of grout.
3. Ground rods shall extend a maximum of 3" above grouting to assure adequate driven depth and allow for adequate connecting space.
4. Ground rods shall extend a minimum of 7' - 6" into earth.
5. Gravel fill is not acceptable.



GROUTING DETAIL FOR TRANSFORMER PAD WINDOWS

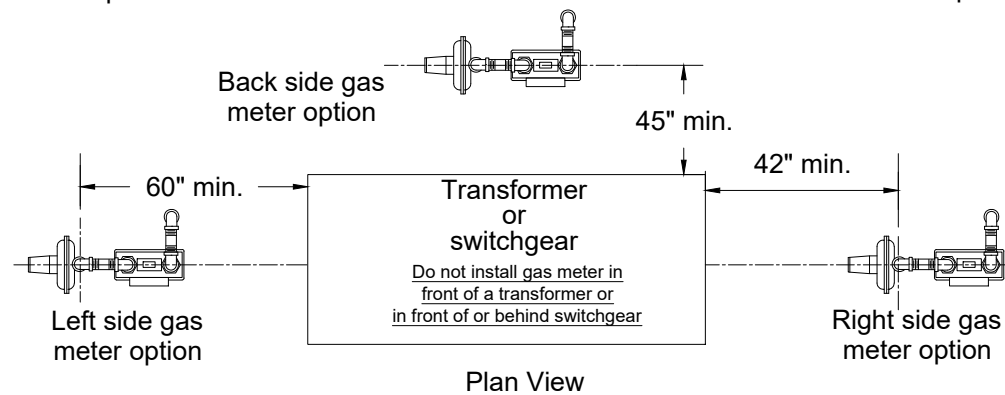
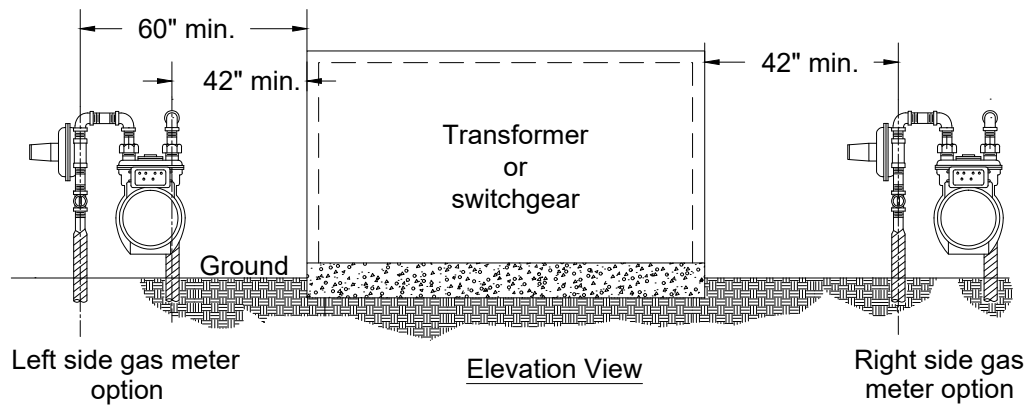

Pedestal Clearance Details

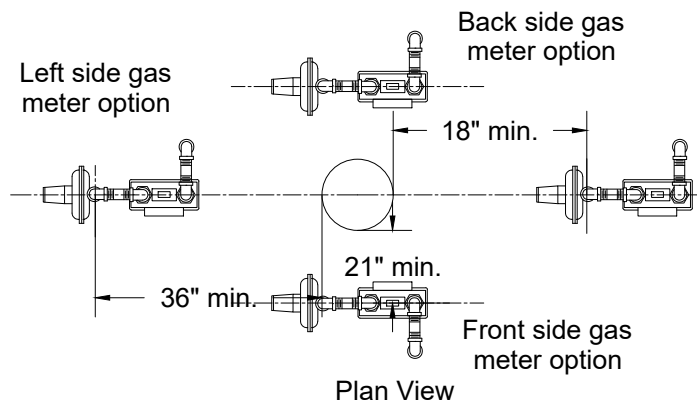
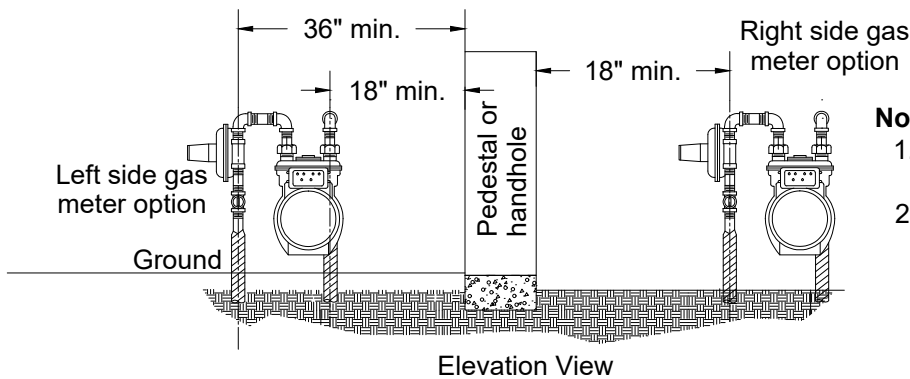

Notes:

1. Measurements are referenced from the inlet gas riser.
2. The measurements will ensure:
 - 2.1. That a minimum clearance of 36" is attained between the entire gas meter installation and the pad mounted equipment and
 - 2.2. That a minimum clearance of 12" is attained between the entire gas meter installation and all other aboveground facilities including electric and other utility pedestals and handholes.
3. This standard applies to 630 gas meter installations and smaller. For larger meter installations, contact company representative for assistance.
4. This drawing is typically used when the gas main is located in an alley or dedicated utility easement.



ABOVE GROUND CLEARANCES FROM GAS METER INSTALLATIONS

DCS - 5 Detail Sheet 5 of 24

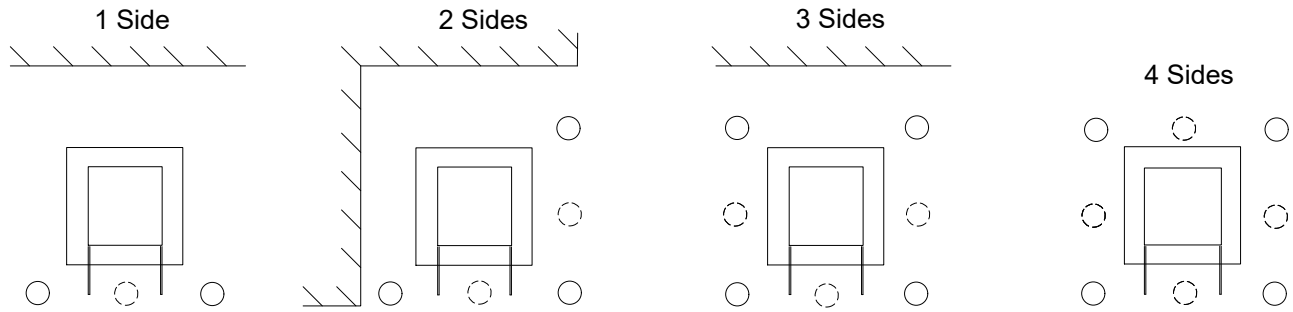

Typical Layout for Traffic and Parking

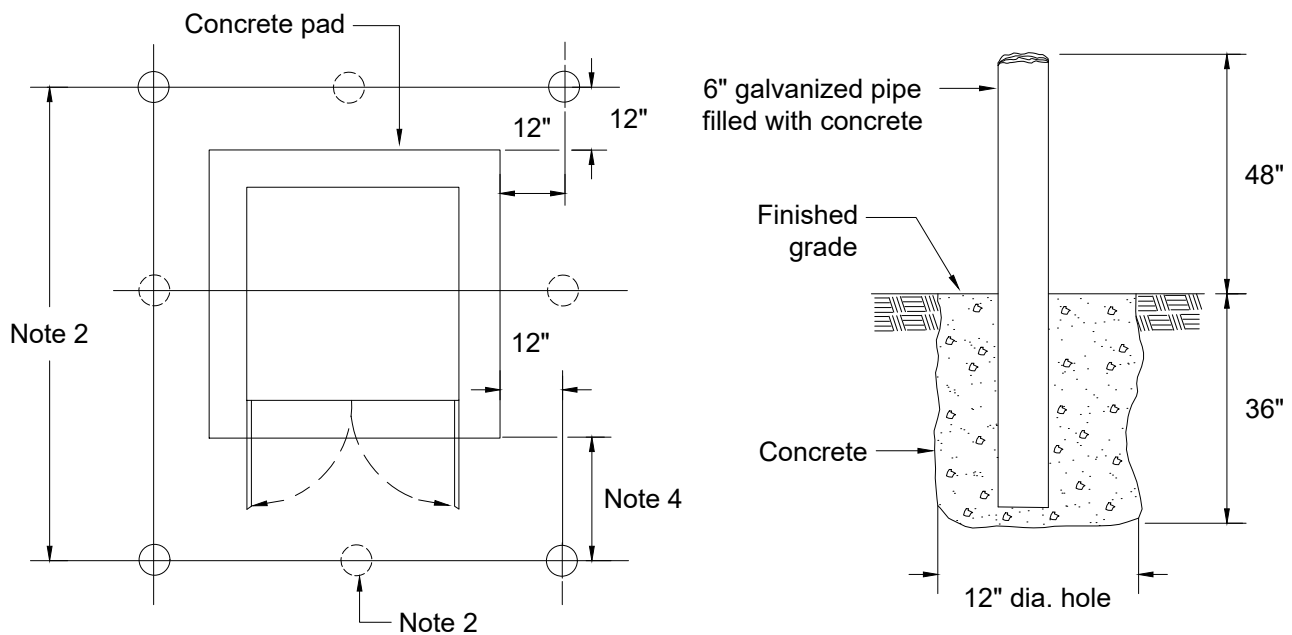

Notes:

1. Install guard post where protection from damage due to vehicular traffic is needed.
2. Distance between posts should not exceed 4'. Add additional posts where necessary to meet this condition. Verify location of post in front of transformer to allow for door opening (or removable post can be installed to achieve clearance).
3. Increase height to 48" and depth to 36" in truck loading areas, and increase size to 6" galvanized pipe.
4. This distance to be large enough to allow full opening of all equipment door(s). Contact company representative to verify dimension.



GUARD POST INSTALLATION

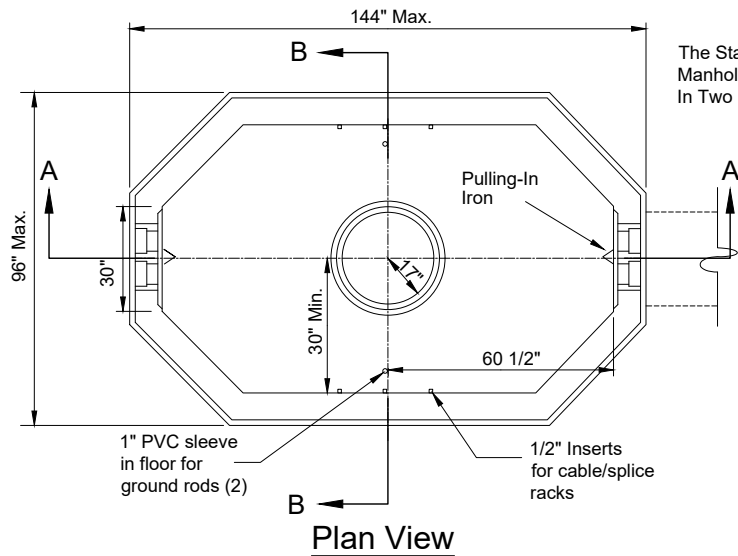

The Standard Two Way Manhole Is Manufactured In Two Sections

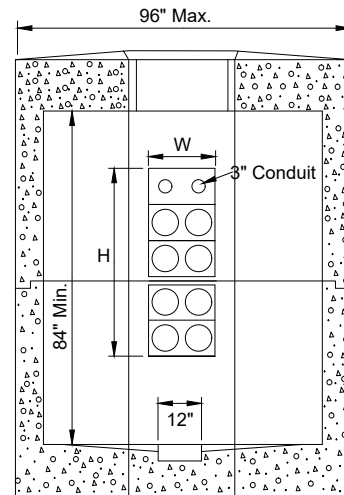
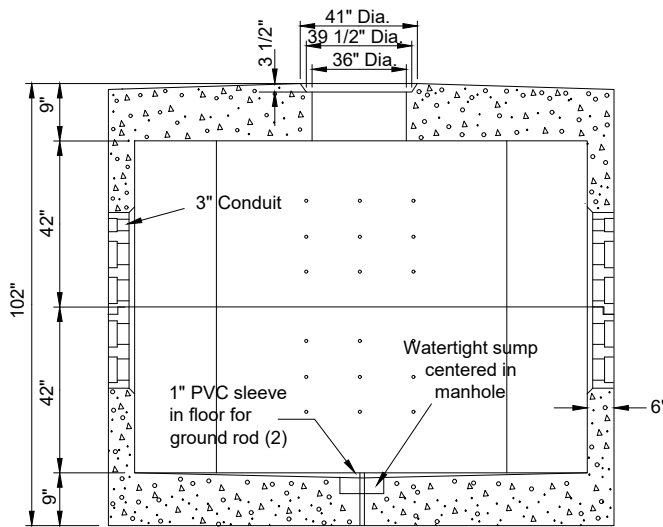
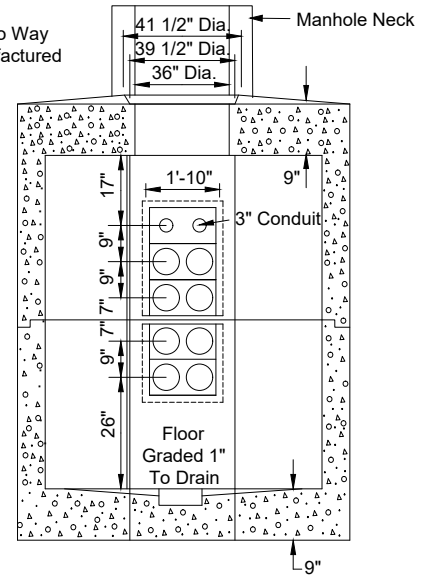

Section A - A

Section B - B

Notes:

- A. The maximum design depth for a manhole is 20 feet to the finished floor. This includes 12 feet of neck (for depth greater than this contact authorized oncor representative).
- B. All joints between manhole sections and manhole neck sections shall be painted with Ram-Nek primer or approved equal by manhole supplier. All joints are to be made watertight at the time of initial installation.
- C. To prevent water and debris migration into the manhole, do not remove the knock out membrane from unused terminator positions. Also, duct plugs should be installed in all conduits that are unoccupied by cable.
- D. A minimum of two 5/8" x 8' copper clad ground rods shall be installed in each manhole.
- E. Precast concrete manholes are to be installed on a minimum 18" gravel base to facilitate leveling.

Approved vendors for 2-way precast concrete manhole (TSN 323109) w/ cover & frame.

- A. Old Castle Precast (Part Number - 912 Series)
- B. Hanson Pipe & Precast (Part Number - Hanson-2Way)
- C. The Turner Company (Part Number - ELMH2WAY)



MANHOLE LARGE TWO WAY PRECAST REINFORCED CONCRETE

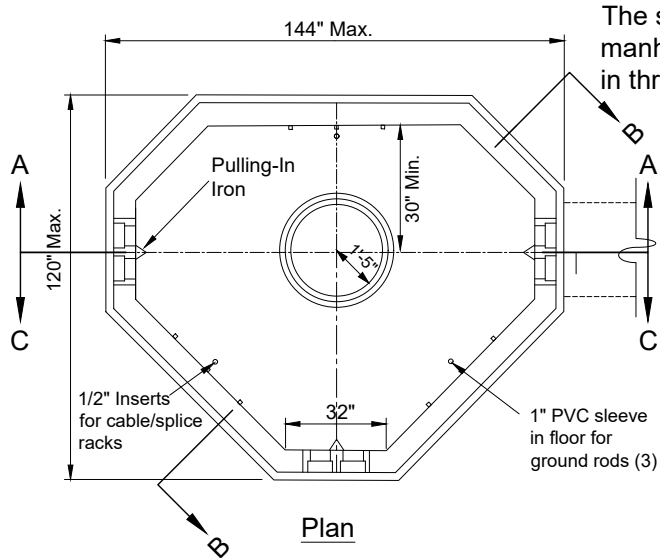

The standard three way manhole is manufactured in three sections

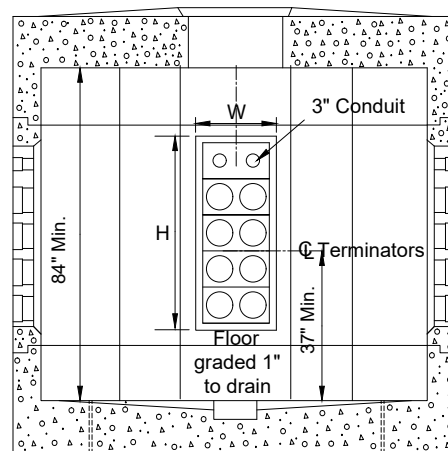
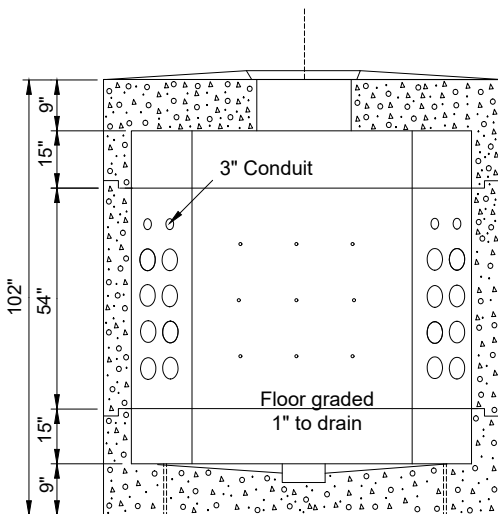
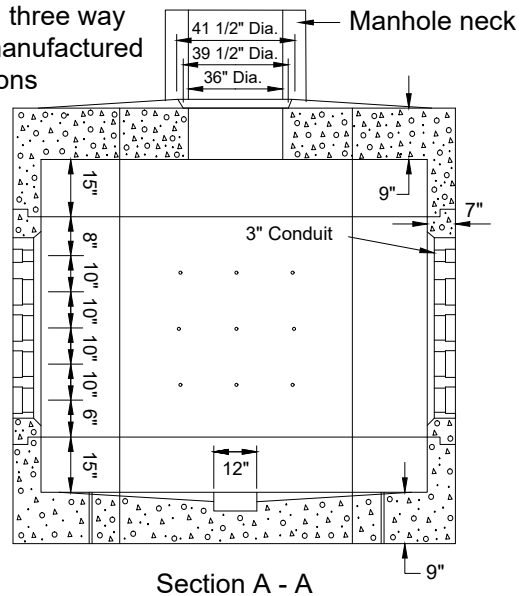

Section B - B

Section C - C

Notes:

- A. The maximum design depth for a manhole is 20 feet to the finished floor. This includes 12 feet of neck (for depth greater than this contact authorized oncor representative).
- B. All joints between manhole sections and manhole neck sections shall be painted with Ram-Nek primer or approved equal by manhole supplier. All joints are to be made watertight at the time of initial installation.
- C. To prevent water and debris migration into the manhole, do not remove the knock out membrane from unused terminator positions. Also, duct plugs should be installed in all conduits that are unoccupied by cable.
- D. A minimum of two 5/8" x 8' copper clad ground rods shall be installed in each manhole.
- E. Precast concrete manholes are to be installed on a minimum 18" gravel base to facilitate leveling.

Approved vendors for 3-way precast concrete manhole (TSN 323108) w/ cover & frame.

- A. Old Castle Precast (Part Number - 913 Series)
- B. Hanson Pipe & Precast (Part Number - Hanson-3Way)
- C. The Turner Company (Part Number - ELMH3WAY)



MANHOLE LARGE THREE WAY PRECAST REINFORCED CONCRETE

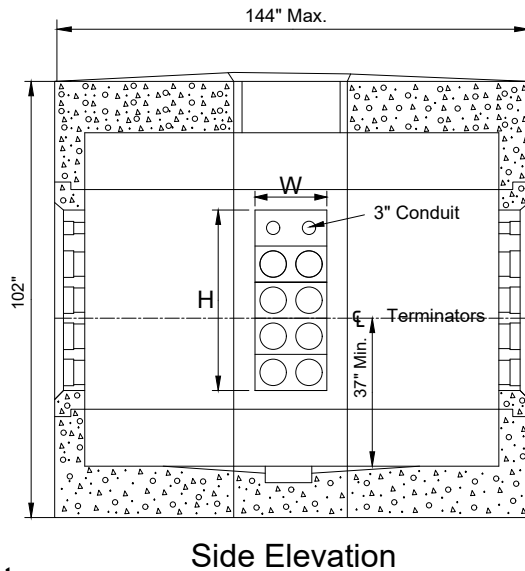
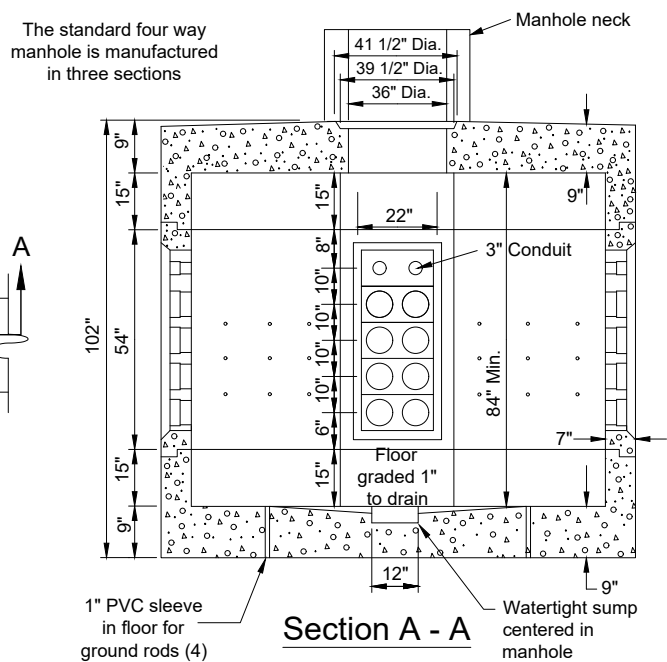
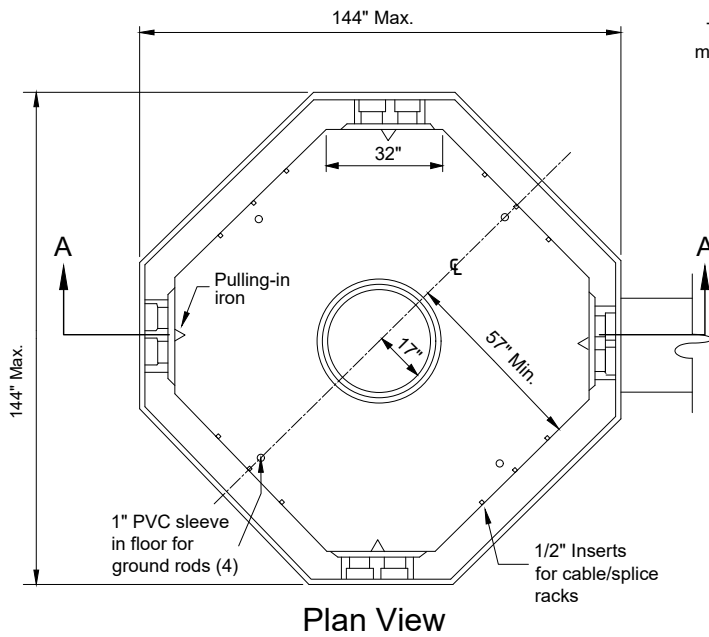

Notes:

- A. The maximum design depth for a manhole is 20 feet to the finished floor. This includes 12 feet of neck (for depth greater than this contact authorized oncor representative).
- B. All joints between manhole sections and manhole neck sections shall be painted with Ram-Nek primer or approved equal by manhole supplier. All joints are to be made watertight at the time of initial installation.
- C. To prevent water and debris migration into the manhole, do not remove the knock out membrane from unused terminator positions. Also, duct plugs should be installed in all conduits that are unoccupied by cable.
- D. A minimum of two 5/8" x 8' copper clad ground rods shall be installed in each manhole.
- E. Precast concrete manholes are to be installed on a minimum 18" gravel base to facilitate leveling.

Approved vendors for 3-way precast concrete manhole (TSN 316942) w/ cover & frame.

- A. Old Castle Precast (Part Number - 914 Series)
- B. Hanson Pipe & Precast (Part Number - Hanson-4Way)
- C. The Turner Company (Part Number - ELMH4WAY)



MANHOLE LARGE FOUR WAY PRECAST REINFORCED CONCRETE

DCS - 5 Detail Sheet 9 of 24

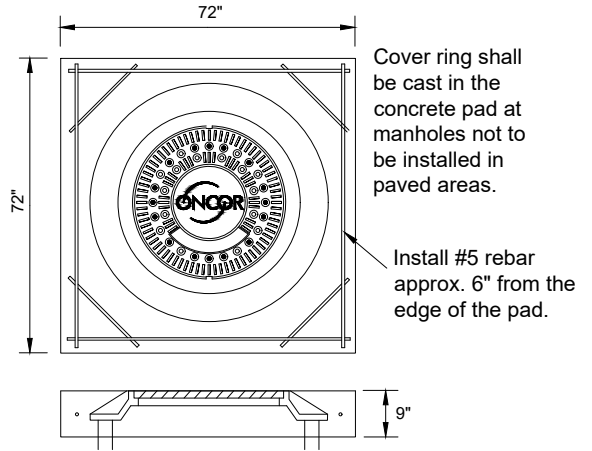
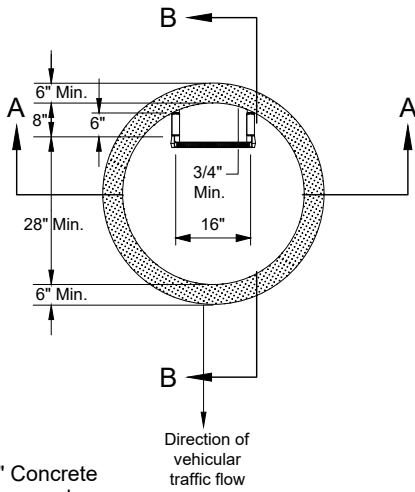

Entrance Pad Detail

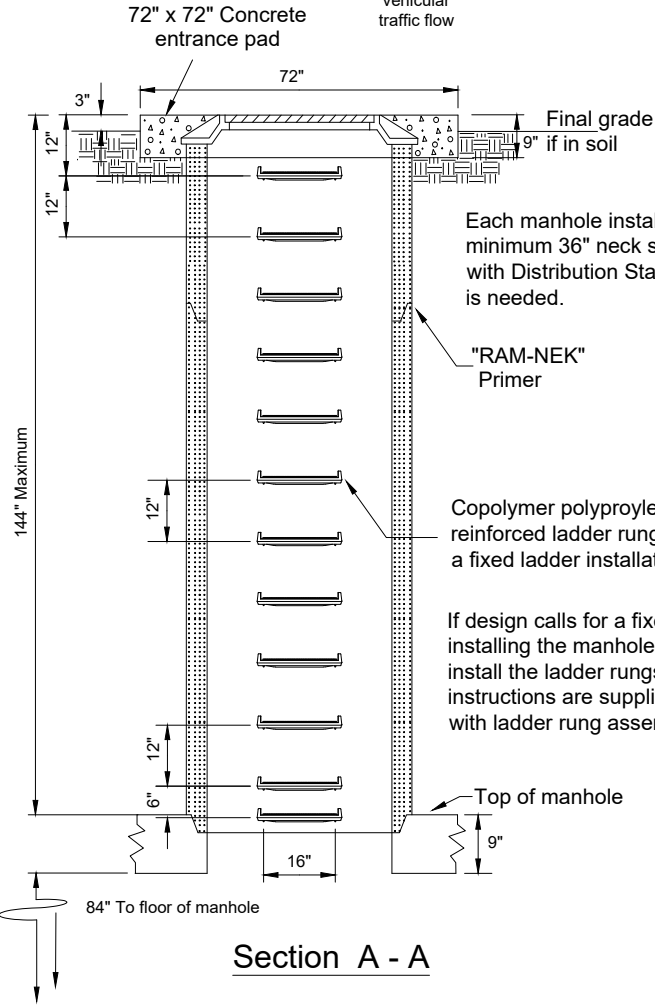

Section A - A

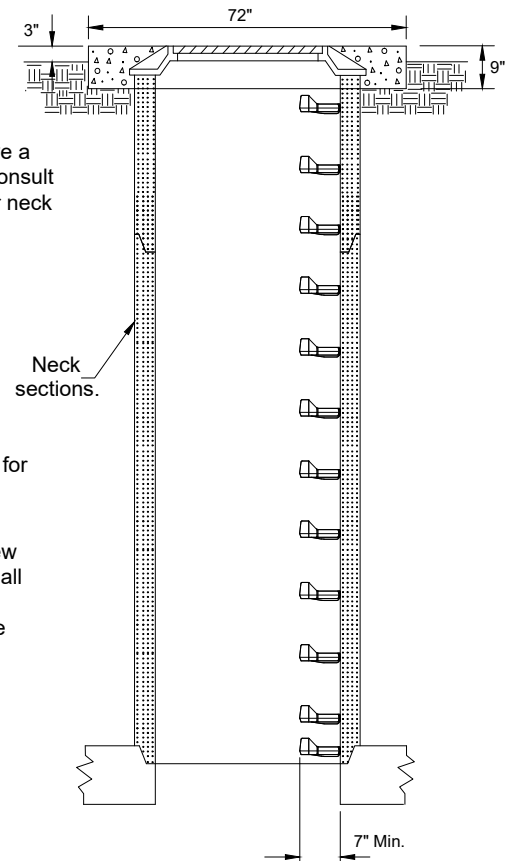

Section B - B



MANHOLE NECK, LADDER AND ENTRANCE PAD INSTALLATION

Description & Approved Vendors	Oncor TSN	Vendor Part #
12" x 36" Precast Concrete Neck Section	320774	
Old Castle Precast		048060
Hanson Pipe & Precast		HANSON-12NECK36
The Turner Company		ELGR3612
18" x 36" Precast Concrete Neck Section	320775	
Old Castle Precast		048080
Hanson Pipe & Precast		HANSON-18NECK36
The Turner Company		ELGR3618
24" x 36" Precast Concrete Neck Section	320776	
Old Castle Precast		048090
Hanson Pipe & Precast		HANSON-24NECK36
The Turner Company		ELGR3624
36" x 36" Precast Concrete Neck Section	320777	
Old Castle Precast		048060
Hanson Pipe & Precast		HANSON-36NECK36
The Turner Company		ELGR3636
Manhole Step, Plastic Steel Reinforced, Drive in Single Rung	482911	
M.A. Industries		PS-3-PCF/004-516



**MANHOLE NECK, LADDER AND
ENTRANCE PAD INSTALLATION**

DCS - 5 Detail Sheet 11 of 24

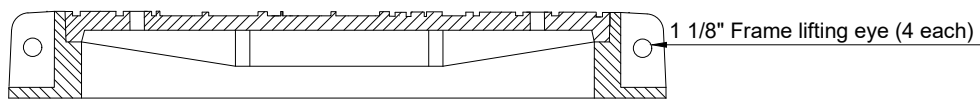
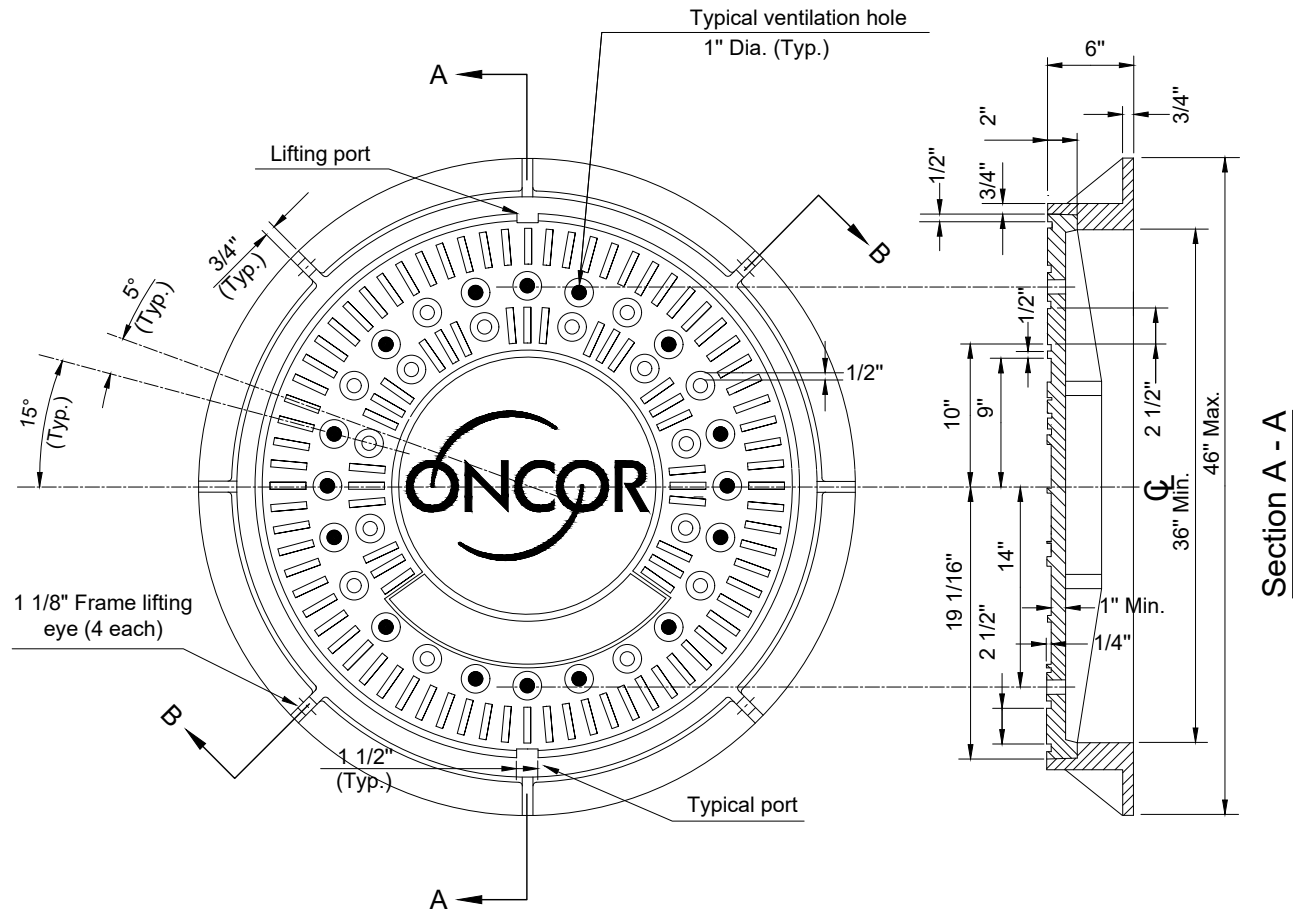

Section B - B

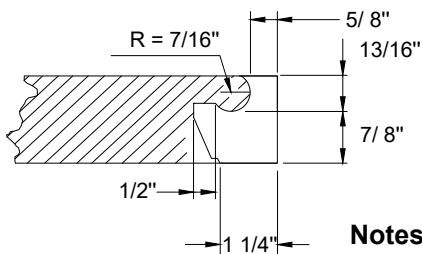

Lifting Port Section
Detail

Notes:

- A. Bearing surface between cover and frame shall be machined.
- B. Cover and frame shall be constructed to (AASHITO H-20 FULL TRAFFIC) rating load requirements.
- C. Cover and frame shall be constructed of gray cast iron conforming to ASTM-48-LATEST REVISION CLASS 35B.
- D. Manhole cover and frame shall not exceed 700 lbs.

Approved vendors for (TSN 327563) manhole cover and frame.

- A. Old Castle Precast (Part Number - MHRL2010)
- B. The Turner Company (Part Number - ELCVR36)



**MANHOLE COVER AND
FRAME DETAIL**

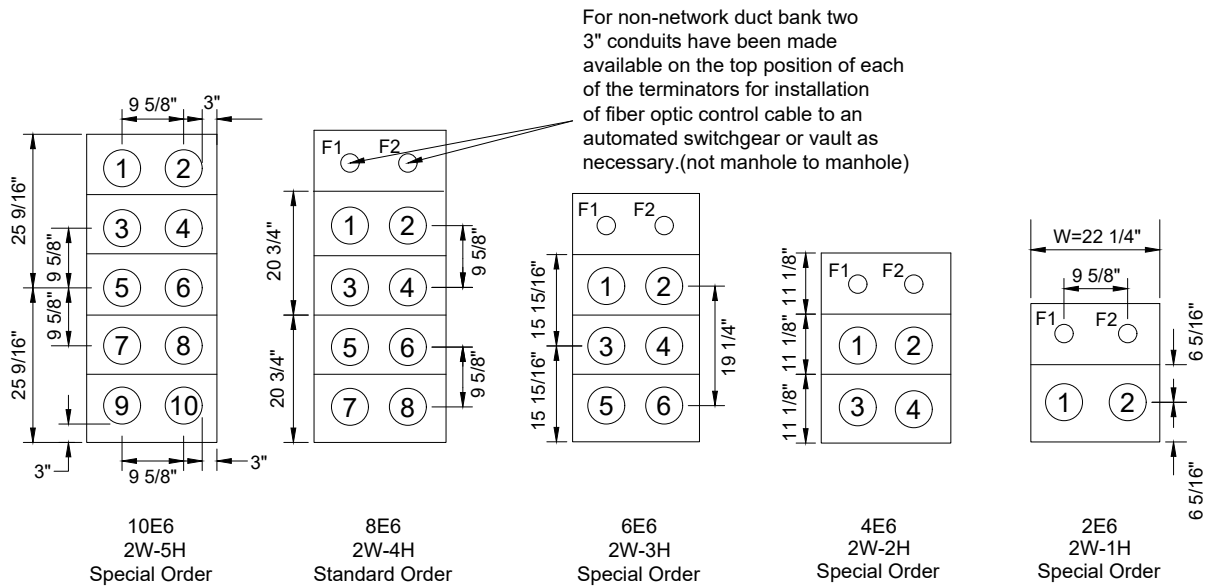

Alignment for Non-network Manhole Duct Termination for 6" Conduit (Typical)

Notes:

- The numbering system shown assumes one is standing in the center of the manhole facing the terminator wall.
- In the event that all of the available conduit positions of the terminator are not needed for an installation. The bottom conduit positions should be used first to allow for future conduit exits from the manhole.
- To prevent water and debris migration into the manhole, do not remove the "knock-out" Membranes of any unused terminator position. Also duct plugs should be installed in all conduits that are unoccupied by cable.
- Cable sizes necessary for non-network duct systems will require 6 inch conduit/duct installations.
- The systems depicted above are manhole facing conduit/duct system terminators only, and should not be mistaken for duct section details.
- The 3 inch conduit for fiber optic cable has been omitted on the 10E6 duct due to a lack of wall space.



**DUCT TERMINATOR ALIGNMENTS
FOR PRECAST CONCRETE MANHOLES**

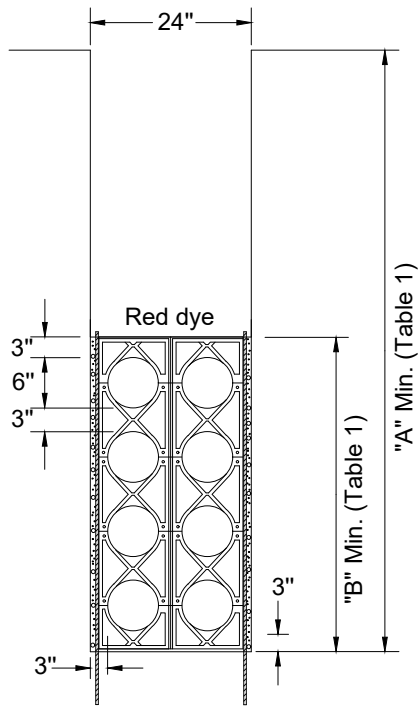

End View of Trench 8E6 Duct
(Typical Non-Network Installation Shown)

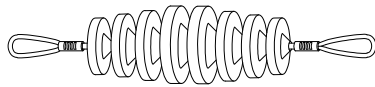

Polyurethane Disk Mandrel

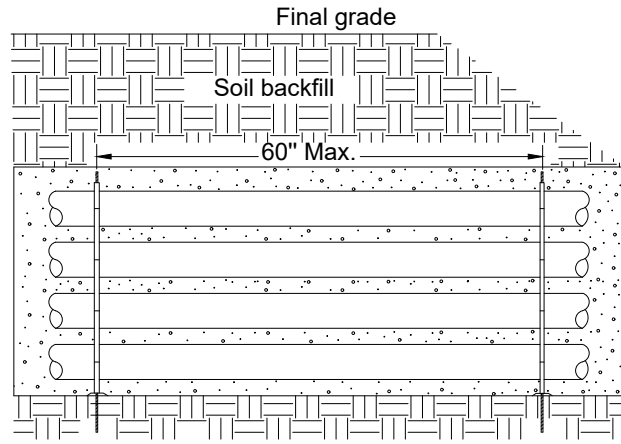

Section of Trench

System	Non-Network Duct (in)				
	2E6	4E6	6E6	8E6	10E6
Dimension					
A (Min.)	43	53	62	72	81
B (Min.)	13	23	32	42	51

Table 1

1 Cubic Yard of Concrete	2E6	4E6	6E6	8E6	10E6
Coverage (ft)	16.875	8.438	6.819	4.956	3.99

Table 2

Normal Duct Size Non-Network	Max. Disk Diameter	Total Weight
6" Duct Conduit	5"	6.20 lbs

Mandrel Sizes

Notes:

- A. Conduit for concrete encasement is to be solid wall pvc DB-60 and shall not be a cellular core pvc product.
- B. All concrete of the encasement is to have a compression test strength of 3000 psi at twenty eight days.
- C. Install approved duct spacers (see below) every 5 feet along the entire length of the conduit system.
- D. The duct spacers are to provide 3 inches of vertical and horizontal separation between the conduits.
- E. The duct line shall be secured to earth at a minimum of each fourth spacer location or every 20' along the duct prior to pouring concrete to prevent the conduit from floating.
- F. All conduit/duct spans should be installed with a slope towards each of the manholes to provide drainage of water to a pumpable location.
- G. All backfill of a conduit/duct trench shall be replaced to a minimum soil compaction of 95%.
- H. Red powder concrete dye is to be placed on the duct encasement cap immediately after the concrete pour has taken place to aid with future locates of the primary duct line.
- I. Conduits for incomplete duct lines (STUBS), are to remain exposed from the encasement for future retrieval, be capped water tight and have an electronic marker installed.
- J. Each conduit of a concrete encased duct shall be inspected by pulling a disk mandrel of the proper size through its entire length as soon as possible after the encasement has been poured to insure it's integrity.
- K. Each 6 inch conduit of an encased duct is to have a 6000 lbs pull tape installed for future cable pulling.



**GENERAL GUIDELINES FOR CONCRETE
ENCASED DUCT BANK INSTALLATIONS
(NON-NETWORK)**

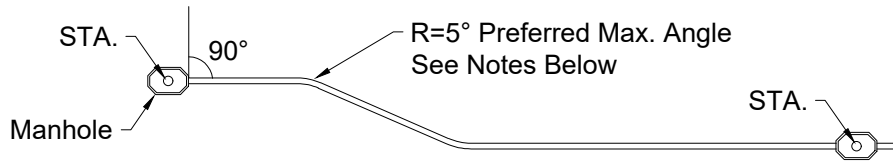

Plan View

Proposed Scale: 1" = 20'

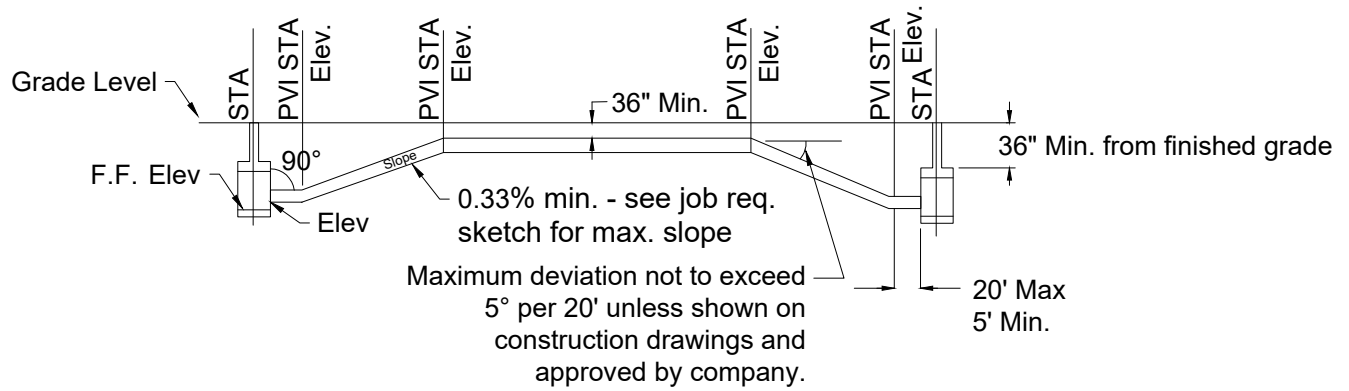

Profile

Proposed Scale: 1" = 20' Horizontally
1" = 5' Vertically

PVI = Point of vertical intersection
R = Radius of deviation

Design Notes:

- A. All sections of conduit shall be run in as straight a line as conditions will permit. Deviations greater than 5° shall be shown on construction plans and approved by company.
- B. Indicate station every 100 feet in plan view and every 50 feet with elevation in profile. Add stations and elevations at each grade change and at manhole entrance.
- C. Indicate manhole finished floor elevation (if distance from grade to floor is greater than 20' a double stack manhole must be installed).
- D. Conduit shall enter terminators at an angle of 90° in the horizontal and vertical planes.
- E. Conduit horizontal center line to match manhole horizontal center line. If more terminators have been installed in manhole than conduits in duct line, use bottom terminators unless otherwise noted.
- F. All duct bank shall have a minimum of 36" of cover from top of duct bank to finished grade.
- G. All manholes should be accessible by trucks (specify clearances).
- H. Ensure all typical drawings are accurate (manhole and duct bank cross sections).
- I. All duct banks should drain to manholes where conditions permit.
- J. The required clearance underneath TxDOT structures is 5' minimum. This includes any drainage structures, ditches, or roads.



**DESIGN SPECIFICATIONS FOR MANHOLE
AND CONDUIT SYSTEM PLAN AND
PROFILE DRAWINGS**

DCS - 5 Detail Sheet 15 of 24

The chemicals used in solvent welding of conduit are intended to penetrate the surface of both pipe and fitting, which after curing result in a complete fusion at the joint. The over-use or under-use of chemicals results in leaky joints or weakened pipe.

1. Clean conduit by wiping off all dust, dirt and moisture from surfaces to be cemented either by mechanical or chemical cleaning.
 - 1.1. Mechanical cleaning - Fine abrasive paper or cloth (180 grit or finer) or clean oil-free steel wool.
 - 1.2. Chemical cleaning- Cleaner recommended by manufacturer or equivalent (methyl ethyl ketone - Mek).
2. With a non-synthetic bristle brush apply an even coating of cement to the outside of the pipe and inside the socket. Make sure that the amount of cement applied to the conduit is equal to the depth of the socket. Before assembly, if some evaporation of solvent from the surfaces to be joined is noted, reapply cement, then assemble.

If cement being used has an appreciable change in viscosity or shows signs of jelling, it shall be discarded. In no case shall thinner be used in an attempt to restore jelled PVC cement. Thinner may only be used to change the viscosity of a medium bodied cement to that of a regular bodied cement for application on PVC pipe smaller than 2 1/2" diameter. A medium bodied cement shall be used on 2 1/2" to 6" PVC pipe.

Use a primer to soften the joining surfaces before applying cement. Allow longer cure time. (See item 5).

3. Join pipe within 20 seconds of applying cement. Turn the pipe 1/4 turn to ensure even distribution of cement on surfaces to be bonded. Make sure that pipe is inserted to the full depth of the socket.
4. Clean off any bead or excess cement that appears at the outer shoulder of the fitting. Excess cement allowed to remain in contact with the material is apt to cause weakening of the material, and subsequent failure.
5. Newly assembled joints should be handled carefully until the cement has cured to the recommended set period. Set periods are related to the ambient temperature as follows:

30 min. minimum at 60° to 100° F
1 hr. minimum at 40° to 60° F
2 hr. minimum at 20° to 40° F
4 hr. minimum at 0° to 20° F



INSTRUCTIONS FOR JOINING PVC CONDUIT

DCS - 5 Detail Sheet 16 of 24

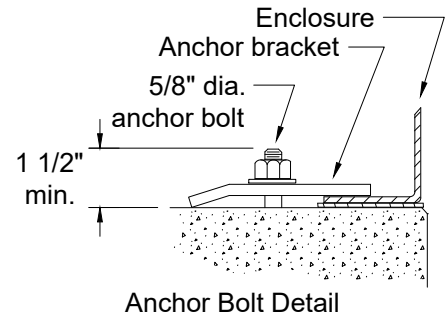
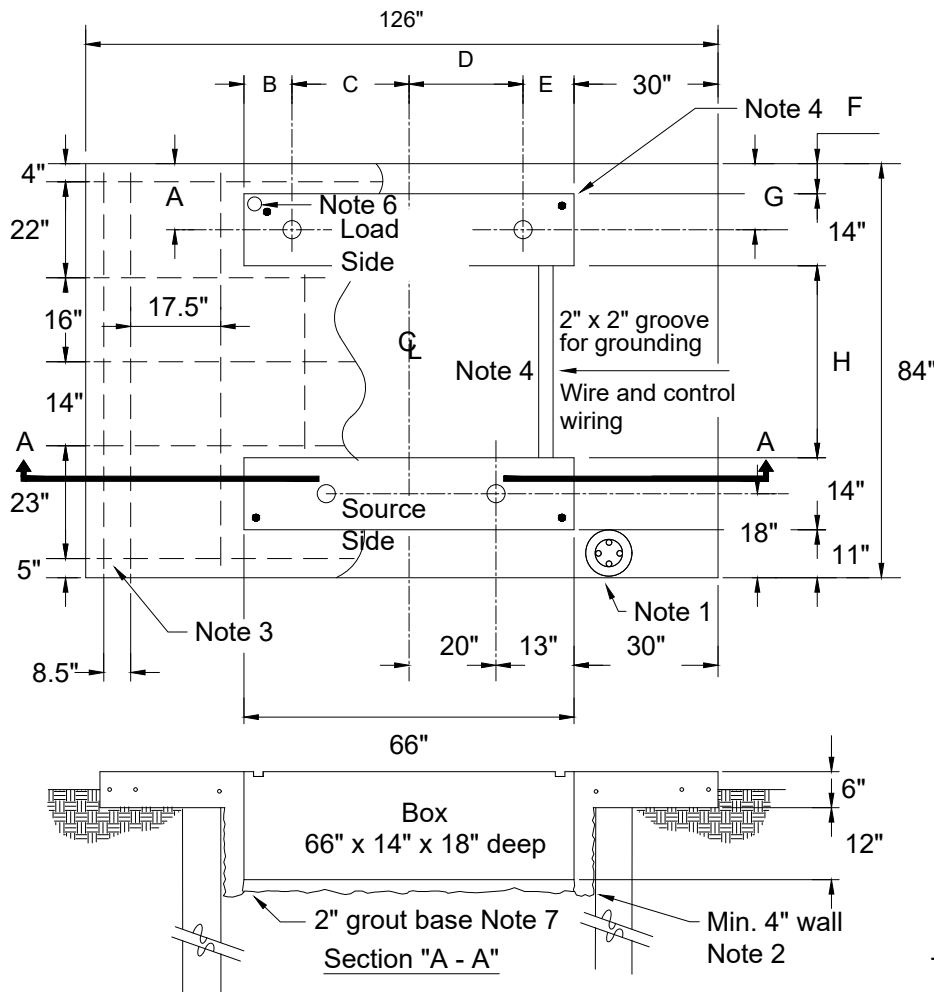

Reinforcing Schedule		
Number of #3 bars	Length	Weight (lbs.)
5	122"	19.1
6	80"	15.0
3	33"	3.1

Total weight (concrete & rebar): 7,040 lbs.

25kV	A	B	C	D	E	F	G	H
PMH - 9	15"	11"	22"	22"	11"	8"	15"	37"
PMH - 10	18"	13"	20"	20"	13"	11"	18"	34"
PMH - 11	15"	11"	22"	20"	13"	8"	18"	37"

Notes:

1. Piers are required on all switchgear pads unless waived by the company inspector. Reference detail sheet 21 for pier detail.
2. Use wire mesh for concrete reinforcement around deep well box.
3. Ends of re-bar shall remain a minimum of 2" inside of concrete and shall be intermediate grade 60 and conform to ASTM A615.
4. Contact company representative on where to acquire 5/8" x 10' copper clad ground rods. Ground rods to be obtained and installed by contractor. Installation depth shall be 7' - 6".
5. For clearances on all sides of the switchgear see detail sheets 1 and 2.
6. For pads plumbed into duct banks, install 3" communication conduit from manhole to front right corner of load side conduit opening of pad.
7. Grout conduit window openings.



**CONCRETE PAD POURED IN PLACE 25 kV
LIVE FRONT AUTOMATED SUPERVISORY
CONTROL SWITCHGEAR**

DCS - 5 Detail Sheet 17 of 24

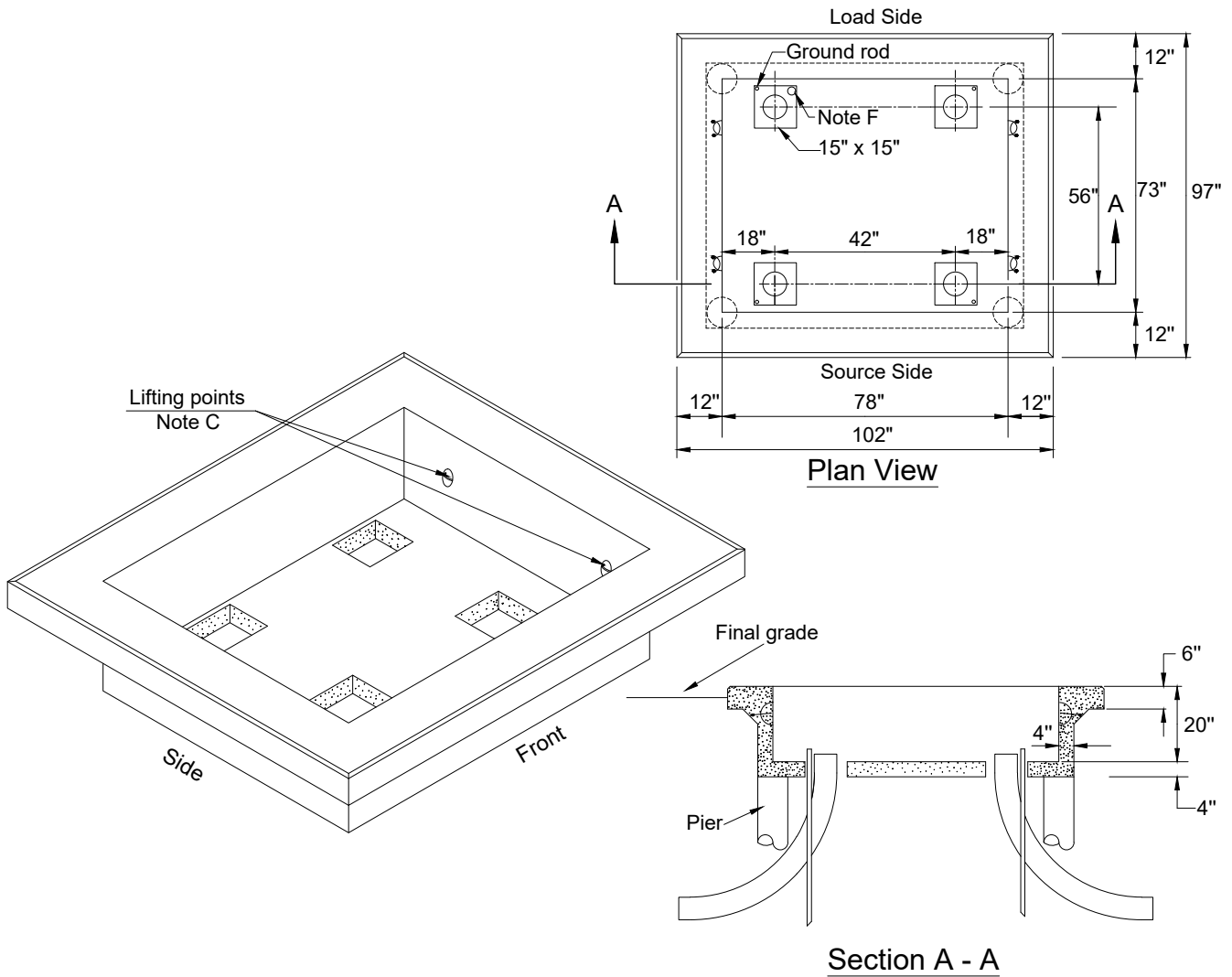

Notes:

- A. To prevent settling and improve pad stabilization add a minimum of 14 inches medium size gravel fill to bottom and around sides.
- B. To help prevent wildlife entry, fill in the windows around the conduits with base gravel to allow for drainage.
- C. Each pad will include four lifting points rated at 2000 lbs each. Total pad weight is 6500 lbs.
- D. For clearances on all sides of the switchgear see Standards Section 202.
- E. Conduit not to extend more than 2 inches above the bottom of the deepwell.
- F. For pads plumbed into manhole/duct banks, install a 3 inches PVC communication/control conduit from manhole to front right corner of load side conduit window opening of the pad.
- G. The need for pier installation is subject to soil conditions and is at the designer and or civil inspectors discretion.

Description & Approved Vendors	Oncor TSN	Vendor Part #
Pad, Precast, 20" Deepwell, Switchgear, 25 kV PMH/PME Type, 103" x 98"	329429	
Old Castle Precast		1804702
The Turner Company		ELPAD25KV
Rod, DRD, CU Clad STL, 5/8" x 10', UL Label & Dimen Stamped on top	306212	
ERITECH		615800



**PRECAST DEEP WELL PAD 25 kV
DEAD FRONT / LIVE FRONT AIR
INSULATED SWITCHGEAR**

DCS - 5 Detail Sheet 18 of 24

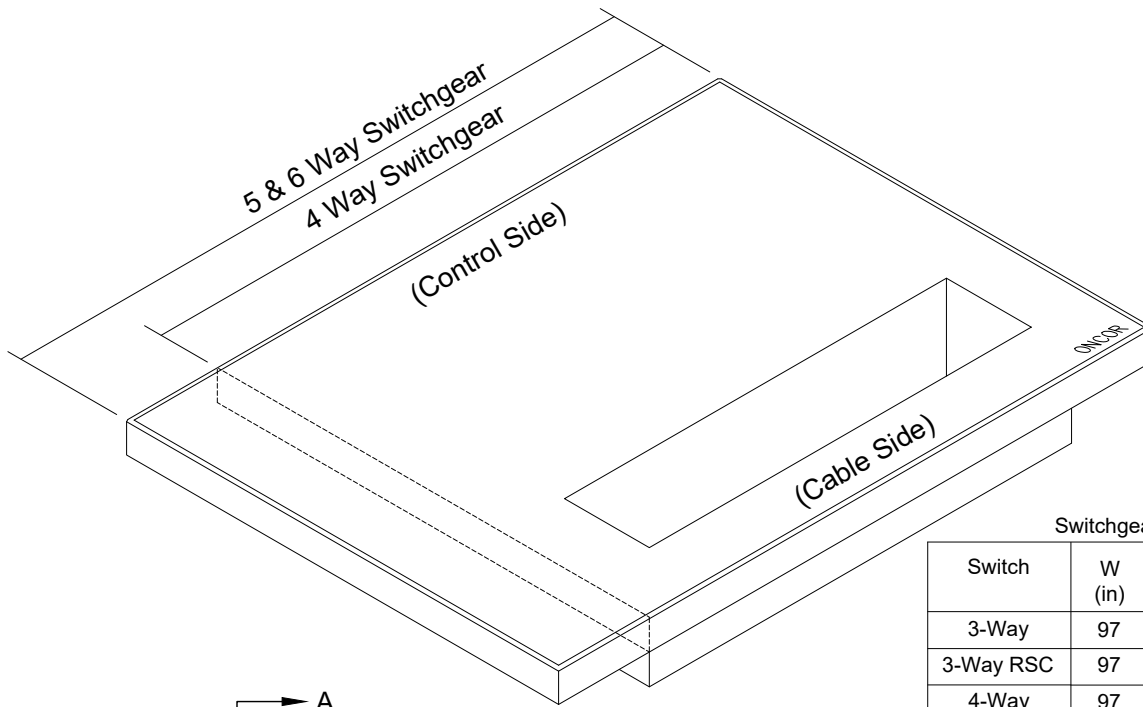

Switchgear Ways

Switch	W (in)	B (in)	D (in)	Weight (lbs)
3-Way	97	64	75	4127
3-Way RSC	97	64	75	
4-Way	97	64	75	
5-6 Way	127 1/2	94	75	5465
4-5 Way ATO	127 1/2	94	75	
4-5 Way RSC	127 1/2	94	75	

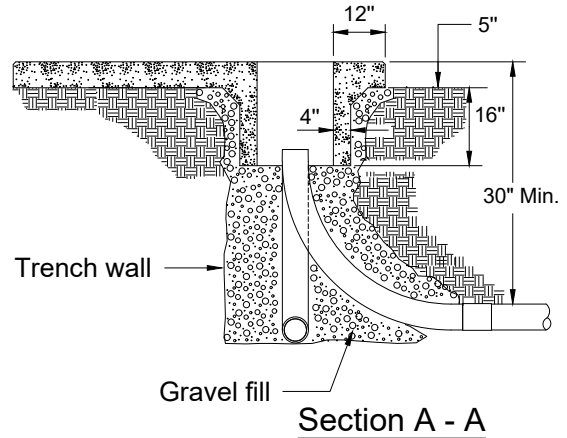
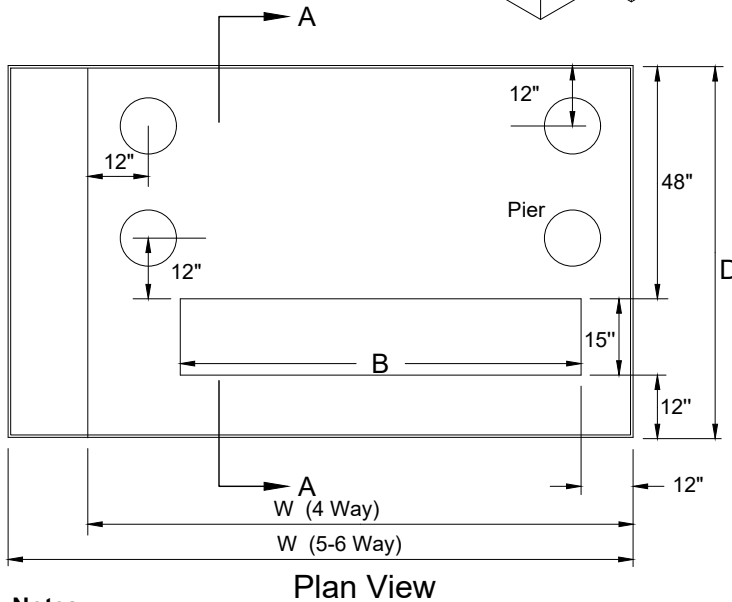

Notes:

- A. To prevent settling and improve pad stabilization add a minimum of 14 inches of medium size gravel fill to bottom and around sides.
- B. To help prevent wildlife entry, fill in the windows around the conduits with base gravel to allow for drainage.
- C. Each pad will include two lifting points rated at 2000 lbs each. Total pad weights are shown in the table above.
- D. Conduit shall not extend more than 2 inches above the bottom of the deep well.
- E. For pads plumbed into manhole/duct banks, install a 3 inch PVC communication/control conduit from manhole to front right corner of load side conduit window opening of the pad.
- F. The need for pier installation is subject to soil conditions and is at the designer and/or civil inspector's discretion.
- G. Contact Company Representative on where to acquire precast concrete pad.



**PRECAST DEEP WINDOW PAD FOR
25 kV DEAD FRONT SF6 INSULATED
SWITCHGEAR**

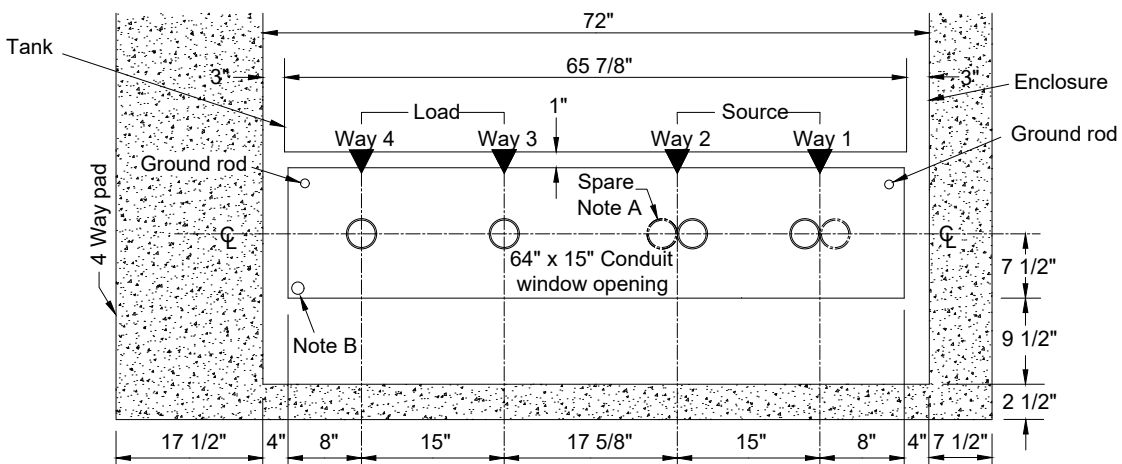
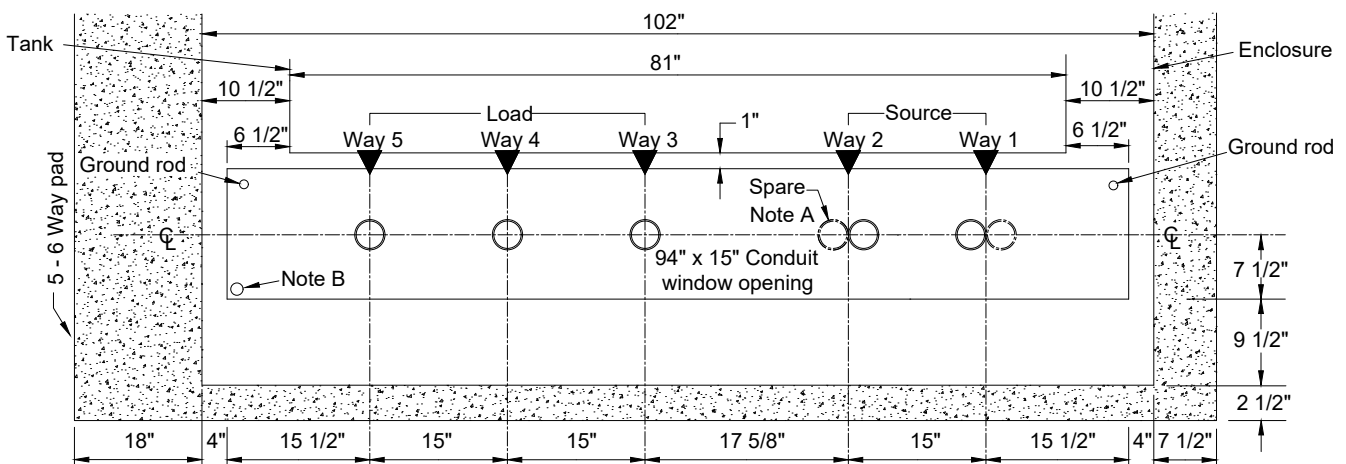
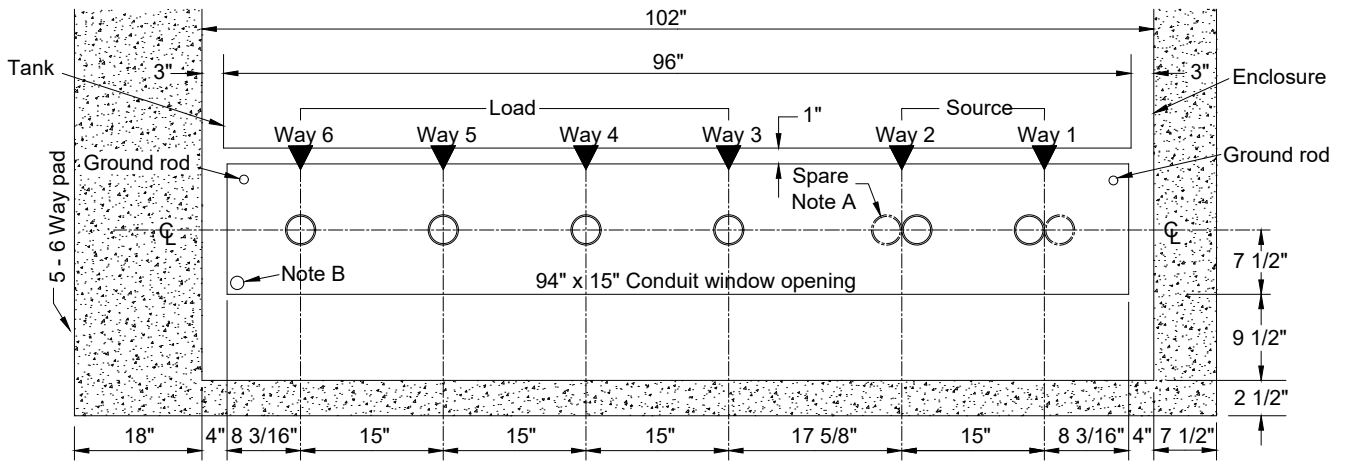

Notes:

- A. Conduit shall be centered on center bushing position of each switched way. If a spare conduit is required, both shall be centered as shown on center bushing position of each switched way.
- B. For pads plumbed into duct banks, install one 3 inch communication/control conduit from the manhole to the front left corner of the conduit window opening of the pad.



**CONDUIT LOCATIONS
DEAD FRONT PAD MOUNT 25 kV SF6
INSULATED SWITCHGEAR (MANUAL
OPERATION)**

DCS - 5 Detail Sheet 20 of 24

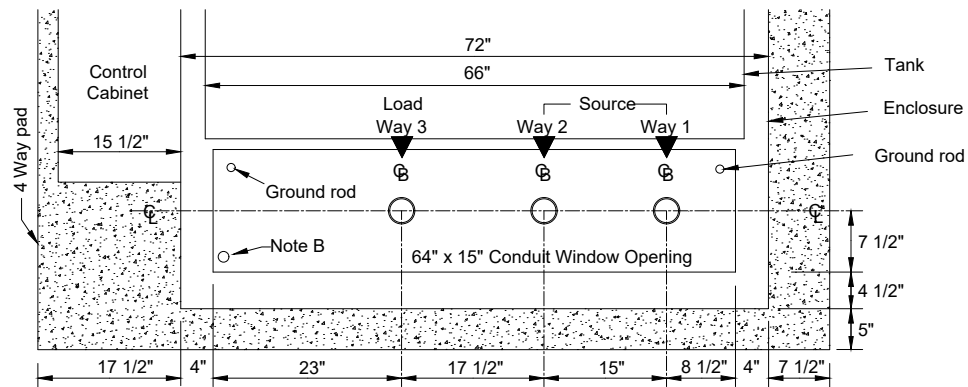
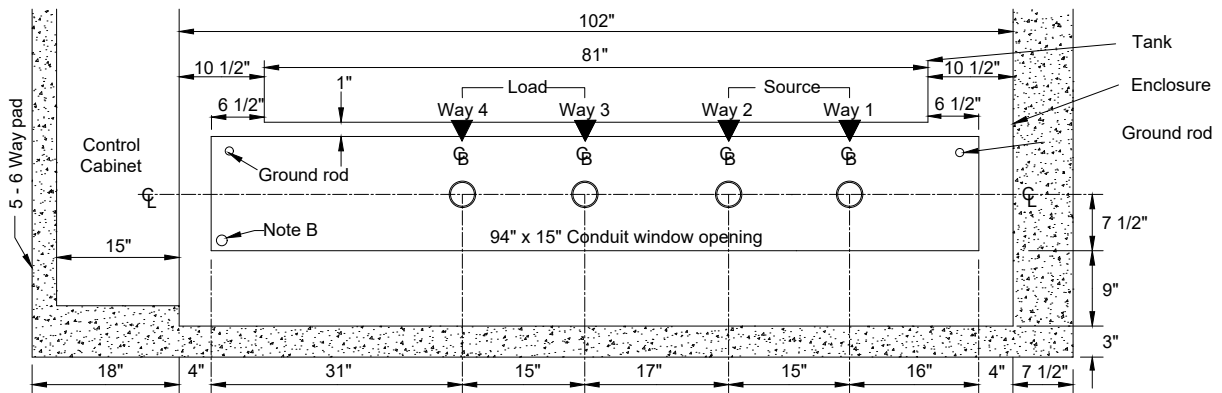
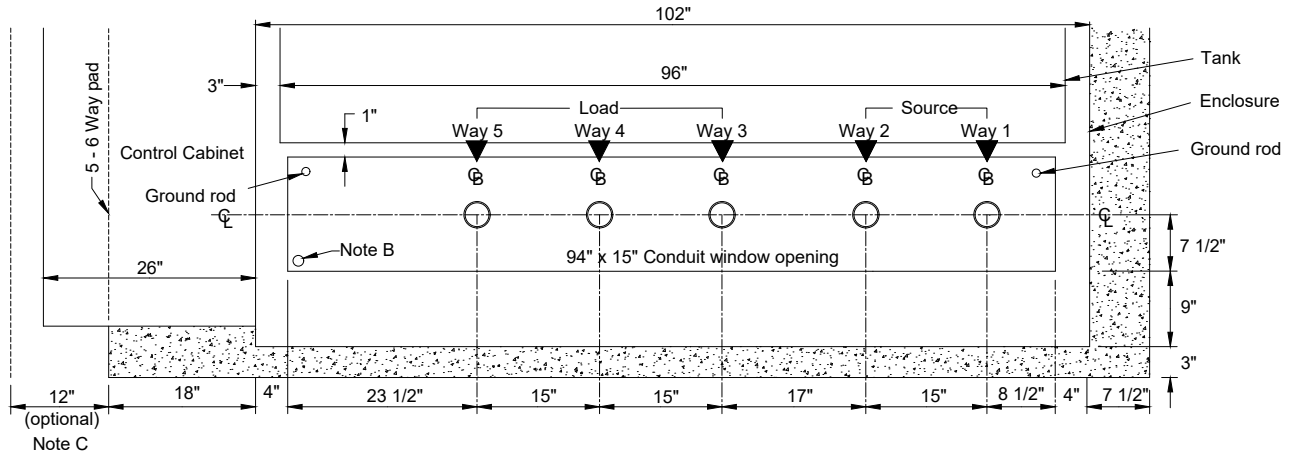

Notes:

- A. Conduit shall be centered on center bushing position of each switched way. If a spare conduit is required, both shall be centered as shown on center bushing position of each switched way.
- B. For pads plumbed into duct banks, install one 3 inch communication/control conduit from the manhole to the front left corner of the conduit window opening of the pad.
- C. To better protect the oversized control cabinet from damage, field pour a concrete pad extension a minimum of 12" x 75" x 6" and dowel into the precast pad approximately every 12 inches to prevent separation.



**CONDUIT LOCATIONS DEAD FRONT
PAD MOUNT 25 kV SF6 INSULATED
SWITCHGEAR (RSC OPERATION)**

DCS - 5 Detail Sheet 21 of 24

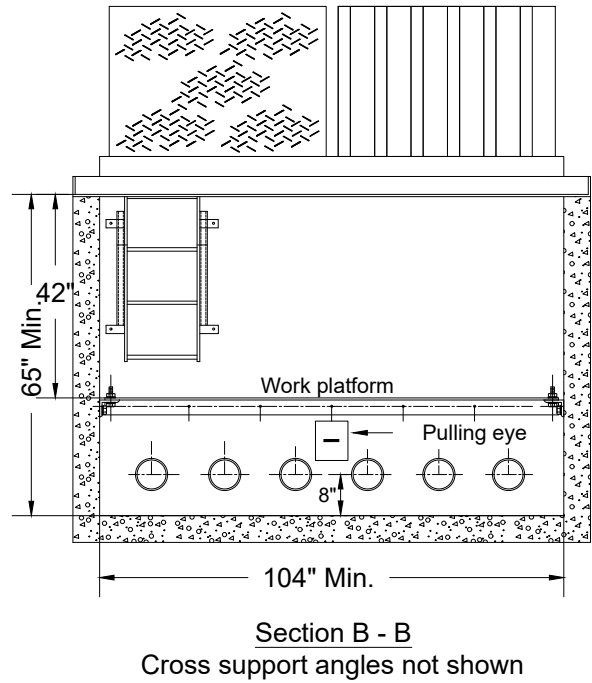
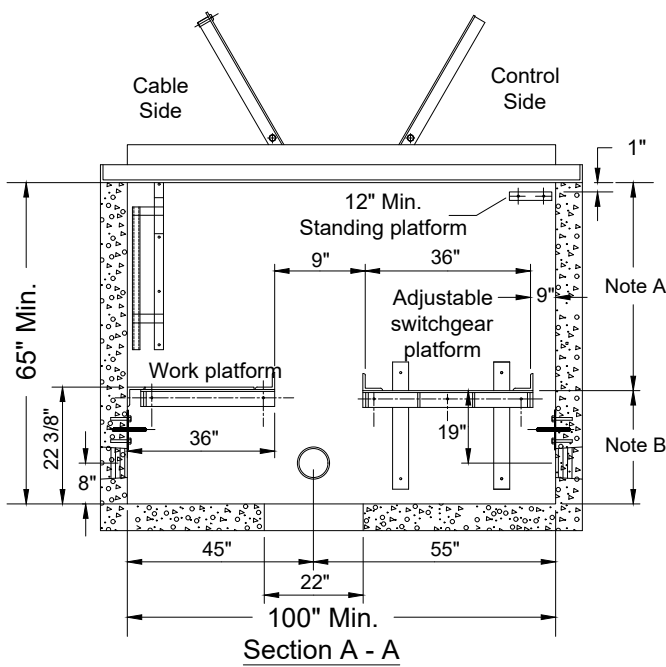
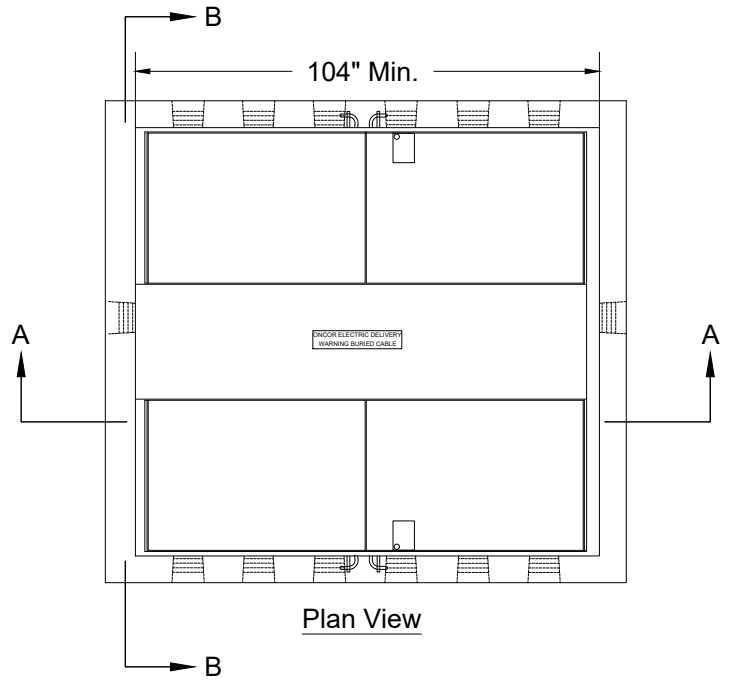
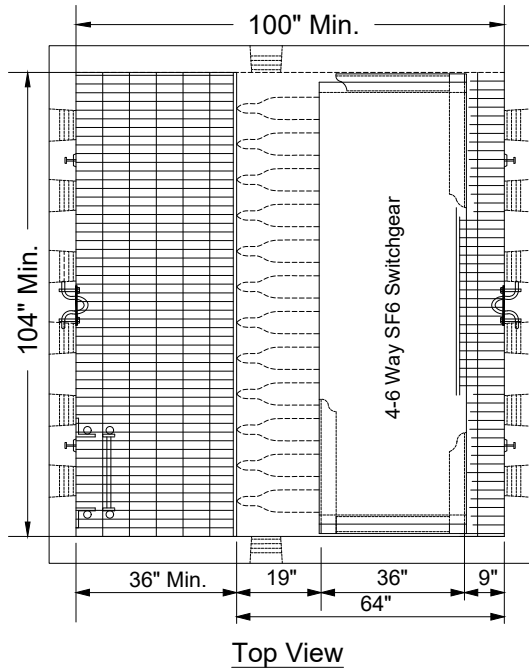

Notes:

- A. 38 inches for motor operator, and 34 inches for manual.
- B. 27 inches for motor operator, 31 inches for manual.



**PRECAST CONCRETE VAULT
FOR SUBSURFACE DEAD FRONT
SF6 INSULATED SWITCHGEAR**

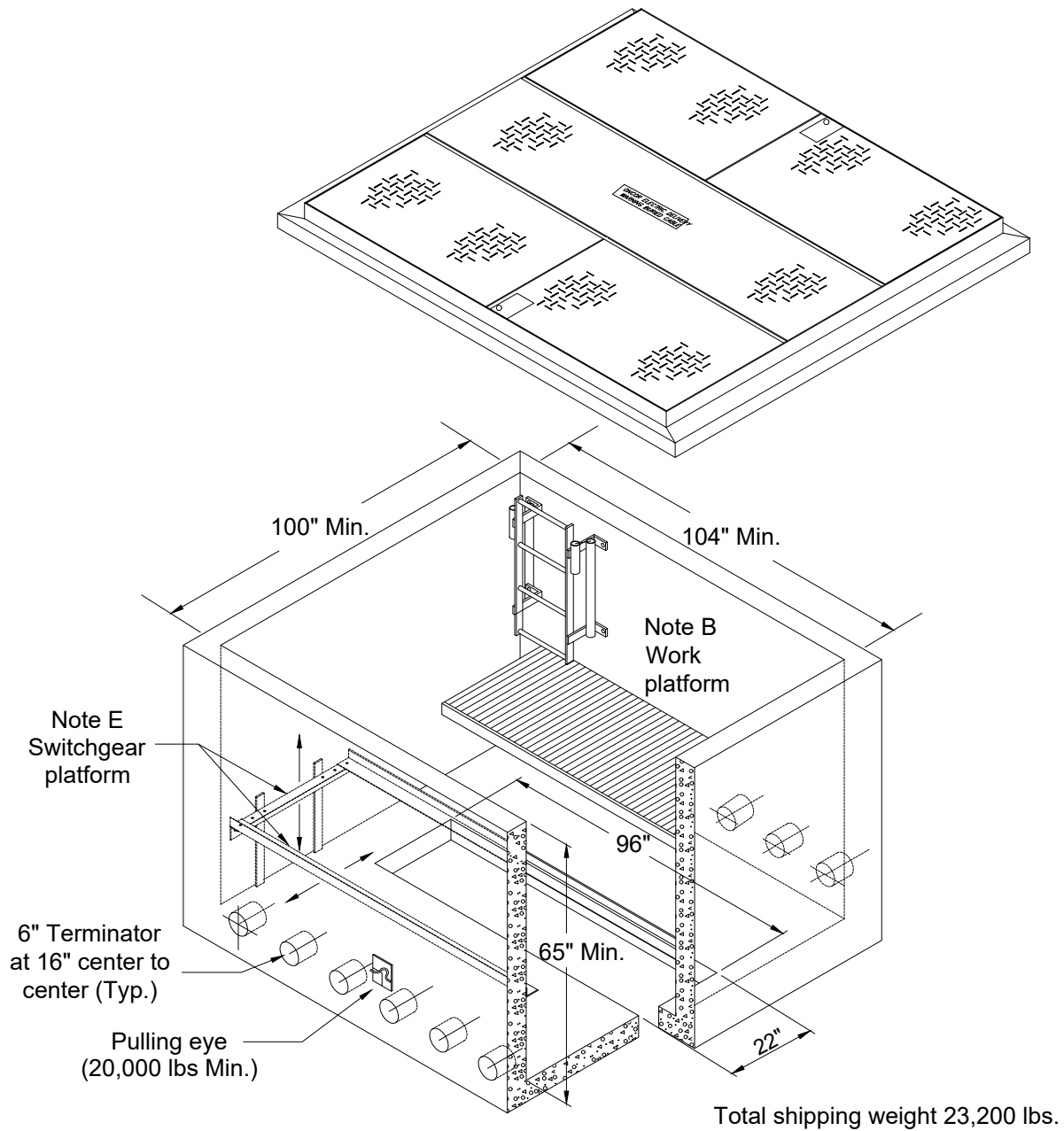

Notes:

- A. Ladder, platforms, support angles and cover are pre-installed by manufacturer.
- B. Vault is equipped with diamond plate steel torsion assisted lift covers.
- C. Vertical loads to cover shall not exceed 16,000 lbs live wheel weight.
- D. Vaults shall not be installed in locations designated accessible by vehicular traffic.
- E. Adjustable mounting platform is installed for 4-6 way SF6 dead front switchgear.
- F. Contact Company Representative for vault ordering information.



**PRECAST CONCRETE VAULT
FOR SUBSURFACED DEAD FRONT
SF6 INSULATED SWITCHGEAR**

DCS - 5 Detail Sheet 23 of 24

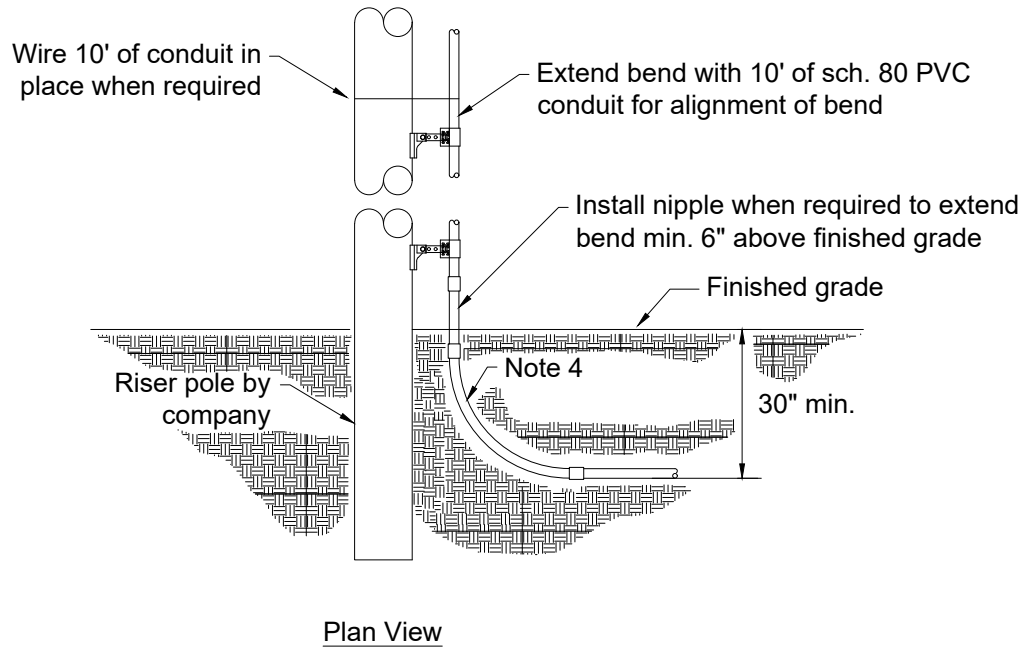
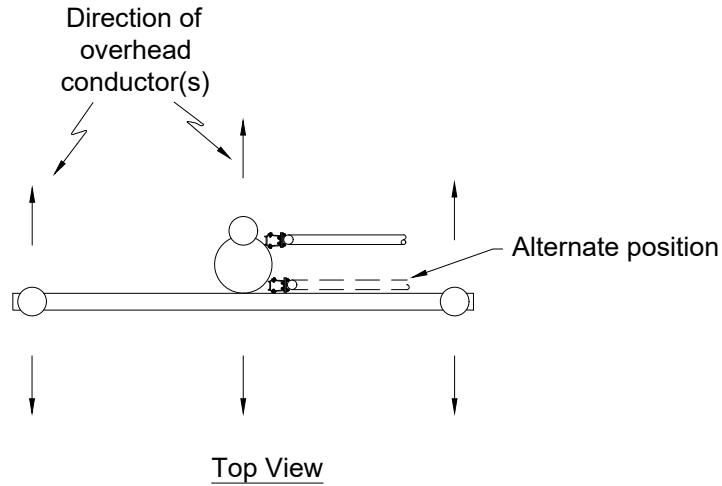

Notes:

1. Contact company representative for (1) routing of conduit line, (2) size of conduit, and (3) installations requiring more than one riser on pole.
2. Limit raceway to three 90° bends. If more than three 90° bends are required, contact company representative.
3. Distance between 90° bends shall be 5' minimum.
4. All primary horizontal and vertical conduit bends shall be 90 degrees with 36" minimum radius.



**TERMINATION OF PRIMARY CONDUIT
AT RISER POLE**

DCS - 5 Detail Sheet 24 of 24